

Plate Door Handles



We take the worry out of
protecting what's valuable to you.
Lockwood: *no worries*[®]

LOCKWOOD

ASSA ABLOY

25YEAR

**MECHANICAL
WARRANTY**

www.lockweb.com.au

Contents



1800 Series

Square End Brass Plate Furniture

page 4



2800 Series

Round End Brass Plate Furniture

page 6



4800 Series

Narrow Plate Brass Door Furniture

page 9



5800 Series

Narrow Plate Brass Door Furniture

page 12



Brass Levers

page 18



200 Series Artefact

Square Corner Plate Furniture

page 27



202 Series Artefact

Radius Corner Plate Furniture

page 29



212 Series Artefact

Oval Corner Plate Furniture

page 32



224 Series Artefact

Rectangular Plate Furniture

page 34



Detention Series

Square and Rectangular Furniture

page 37



Palladium Series

Door Handles

page 47



Diecast Levers

page 51



Finishes

page 58

Brass Furniture Thicker Door Accessories _____ 56

Lockwood Door Furniture Handing Convention _____ 57

1800 Series Square End Brass Plate Furniture



The 1800 Series features a classic rectangular plate with bevelled edges. Suits corporate, commercial and public spaces with high use requirements.

Application

Designed for use with Lockwood Selector and Synergy Mortice Locks and Latches.

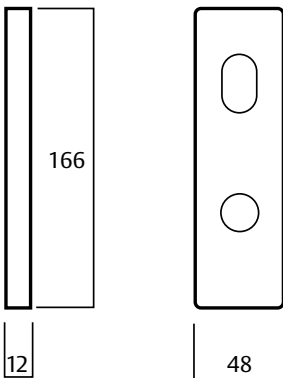

Product Details

Door Thickness

External plates are supplied with fixing screws to suit door thickness between 32 and 45mm. For thicker doors, please refer to the brass furniture thicker doors page at the end of this catalogue section.

Dimensions

166 x 48 x 12mm

Fixing

Plates are designed to fit back to back. If outside plate is specified with concealed fixing, then the inside plate must be visible fixed.

Handing

Plates are not handed; levers may be reversed by removing the stop screw, except for handed levers and functions as shown in the ordering procedure at the end of this section.

Decorative Finishes

Standard Finish:

Satin Chrome Brushed (SC)

Non Standard Finishes:

Chrome Plate (CP)

Polished Brass (PB)

Polyester Powdercoat (PC)*

Special Finishes:

Architectural Bronze (AZ)

Architectural Bronze Unlaqured (AU)

Antique Copper (AC)

Oil Rubbed Bronze (ORB)

Polished Brass Unlaqured (BU)

Satin Brass (SB)

Turn Functions

Turn functions feature a unique mechanism that automatically adjusts the length of the tail bar to suit a particular door thickness.

Adjustable

Tailbar

* Refer to the end of this catalogue for detailed images of all decorative finishes that suit this range.

Standards and Compliance



1800 series has been successfully tested up to 4 hours with a fire rated Lockwood mortice lock on fire door assemblies (depending on type of doorset) in accordance with Australian Standard AS1905.1:2005, Fire Resistant Doorsets.

S8

1800 series door furniture has been successfully tested with a Selector 3772 mortice lock and Abloy Protec² CY504 cylinder to conform with Level SL8 under AS4145.2-2008, Locksets and hardware for doors and windows.

D8

1800 series lever sets have been successfully tested to conform with Level D8 (500,000 cycles) under Australian Standard AS4145.2-2008, Locksets and hardware for doors and windows.



1800 series in brushed satin chrome finish has been successfully tested to conform with Level C10 (1000 hours) under Australian Standard AS4145.2-2008, Locksets and hardware for doors and windows.

1800 Series is designed, assembled and customised in Australia to suit the requirements of the Australian Market.



1800 series includes levers and turns (as shown) that meet the requirements of AS1428.1-2009, Design for access and mobility.

1800 Series Levers and Functions

Plates and Functions

| | | | | | | | | | | | | |
|--|--|---|--|---------------------------------|------------------------------------|------------------------------------|---|--|--|--|---|--|
| 1800 | 1801 | 1803 | 1804 | 1805 | 1806 | 1807 | 1808 | 1809 | 1810 | 1813 | 1814 | |
| | | | | | | | | | | | | |
| Exterior Plate Cylinder Only | Exterior Plate Cylinder & Lever | Exterior Plate Emergency Turn & Lever | Exterior Plate Turnknob & Lever | Exterior Plate Lever Only | Exterior Plate Turnknob Only | Exterior Plate Plain Plate | Exterior Plate Fixed Lever & Cylinder | Exterior Plate Fixed Lever | Exterior Plate Dual Cylinder | Exterior Plate Privacy Indicating Emergency Turn | Exterior Plate Privacy Indicating Emergency Turn & Lever | |
| 1815 | 1816 | 1820 | 1821 | 1822 | 1823 | | | | | | | |
| | | | | | | | | | | | | |
| Exterior Plate Privacy Indicating Turnknob | Exterior Plate Privacy Indicating Turnknob & Lever | Exterior Plate Cylinder, Lever & LED | Exterior Plate Cylinder, Fixed Lever & LED | Exterior Plate Lever & LED | Exterior Plate Cylinder & LED | | | | | | | |
| 1900 | 1901 | 1904 | 1905 | 1906 | 1907 | 1908 | 1909 | 1920 | 1921 | 1922 | 1939* | 1941* |
| | | | | | | | | | | | | |
| Interior Plate Cylinder Only | Interior Plate Cylinder & Lever | Interior Plate Turnknob & Lever | Interior Plate Lever Only | Interior Plate Turnknob Only | Interior Plate Plain Plate | Interior Plate Cylinder & Lever | Interior Plate Fixed Lever | Interior Plate Cylinder, Lever & LED | Interior Plate Cylinder, Fixed Lever & LED | Interior Plate Lever & LED | Interior Plate Disabled Turnknob & Lever | Interior Plate Privacy Indicating Disabled Turnknob & Lever |

* Refer to ordering procedure for part number when ordering with 3770 Series.

Plates and Functions Legend

| | | | | | |
|----------------|--|-------------------|--|---------------------------|--|
| Cylinder Hole | | Fixed Lever | | Indicating Turnknob | |
| Turnknob | | Disabled Turnknob | | Indicating Emergency Turn | |
| Emergency Turn | | LED | | Lever | |

Note: Refer to page 18 for images of levers and knob styles available.

2800 Series Round End Brass Plate Furniture



The 2800 Series features a classic oval shaped plate. Suits corporate, commercial and public spaces with high use requirements.

Application

Designed for use with Lockwood Selector and Synergy Mortice Locks and Latches.

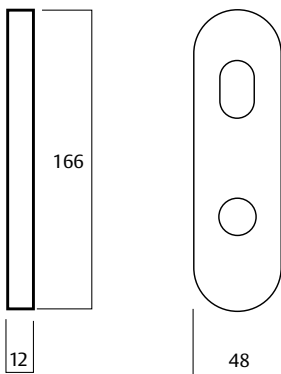

Product Details

Door Thickness

External plates are supplied with fixing screws to suit door thickness between 32 and 45mm. For thicker doors, please refer to the brass furniture thicker doors page at the end of this catalogue section.

Dimensions

166 x 48 x 12mm

Fixing

Plates are designed to fit back to back. If outside plate is specified with concealed fixing, then the inside plate must be visible fixed.

Handing

Plates are not handed; levers may be reversed by removing the stop screw, except for handed levers and functions as shown in the ordering procedure at the end of this section.

Decorative Finishes

Standard Finish:
Satin Chrome Brushed (SC)

Non Standard Finishes:
Chrome Plate (CP)
Polished Brass (PB)
Polyester Powdercoat (PC)*

Special Finishes:
Architectural Bronze (AZ)
Architectural Bronze Unlaqured (AU)
Antique Copper (AC)
Oil Rubbed Bronze (ORB)
Polished Brass Unlaqured (BU)
Satin Brass (SB)

Turn Functions Adjustable Tailbar

Turn functions feature a unique mechanism that automatically adjusts the length of the tail bar to suit a particular door thickness.

* Refer to the end of this catalogue for detailed images of all decorative finishes that suit this range.

Standards and Compliance



2800 Series has been successfully tested up to 4 hours with a fire rated Lockwood mortice lock on fire door assemblies (depending on type of doorset) in accordance with Australian Standard AS1905.1:2005, Fire Resistant Doorsets.

D8

2800 Series lever sets have been successfully tested to conform with Level D8 (500,000 cycles) under Australian Standard AS4145.2-2008, Locksets and hardware for doors and windows.



2800 Series in brushed satin chrome finish has been successfully tested to conform with Level C10 (1000 hours) under Australian Standard AS4145.2-2008, Locksets and hardware for doors and windows.

2800 Series is designed, assembled and customised in Australia to suit the requirements of the Australian Market.



2800 Series includes levers and turns (as shown) that meet the requirements of AS1428.1-2009, Design for access and mobility.

2800 Series Levers and Functions

Plates and Functions

2800 2801 2803 2804 2805 2806 2807 2808 2809 2810 2813

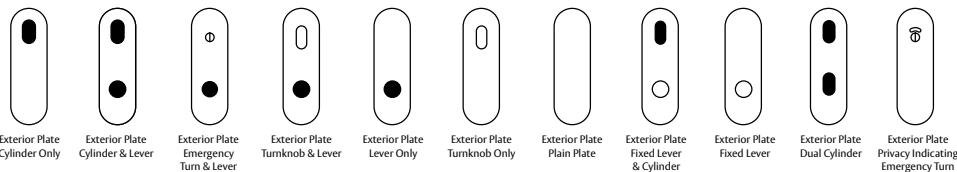

2814 2815 2816 2820 2821 2822 2823

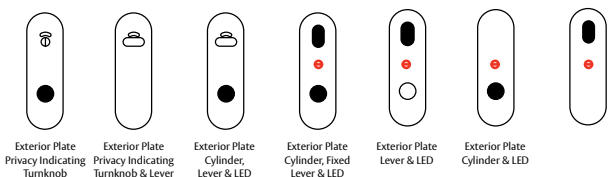

2900 2901 2904 2905 2906 2907 2908 2909 2920 2921 2922 2939* 2941*

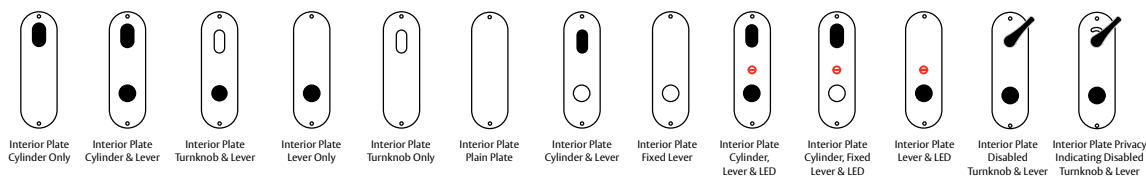

* Refer to ordering procedure for part number when ordering with 3770 Series.

Plates and Functions Legend

| | | | | | |
|----------------|--|-------------------|--|---------------------------|--|
| Cylinder Hole | | Fixed Lever | | Indicating Turnknob | |
| Turnknob | | Disabled Turnknob | | Indicating Emergency Turn | |
| Emergency Turn | | LED | | Lever | |

Note: Refer to page 18 for images of levers and knob styles available.

1800 and 2800 Series Ordering Procedure

For example:

Sample part number 1801/41LCP is made up of several selections. Choose your product by selecting an option from each section.

| | | | | |
|------------|----------------|-------------|---------|--------|
| Plate Type | Plate Function | Lever/ Knob | Handing | Finish |
| 18 | 01 | 41 | L | CP |

Plate Type

| | |
|---------------------|----|
| Exterior Square End | 18 |
| Interior Square End | 19 |
| Exterior Round End | 28 |
| Interior Round End | 29 |

Plate Function

| | |
|---|----|
| Cylinder Only | 00 |
| Cylinder & Lever | 01 |
| Emergency Turn & Lever | 03 |
| Turnknob & Lever | 04 |
| Lever Only | 05 |
| Turnknob Only | 06 |
| Plain Plate | 07 |
| Cylinder & Fixed lever | 08 |
| Fixed Lever Only | 09 |
| Two Cylinders | 10 |
| Privacy Indicating Emergency Turn Only | 13 |
| Privacy Indicating Emergency Turn & Lever | 14 |
| Privacy Indicating Turnknob Only | 15 |
| Privacy Indicating Turnknob & Lever | 16 |
| Privacy Indicating Emergency Turn & Lower Cylinder | 19 |
| Cylinder, Lever & LED | 20 |
| Cylinder, Fixed Lever & LED | 21 |
| Lever & LED | 22 |
| Cylinder & LED | 23 |

Plate Function - Handed

| | |
|--|----|
| Disabled Accessible Turnknob & Lever | 39 |
| Privacy Indicating Disabled Turnknob & Lever | 41 |

AS1428.1 Compliant Lever Types

| | | |
|-----|-----|-----|
| 102 | 111 | 112 |
| 115 | 116 | 118 |
| 124 | 131 | 132 |
| 133 | 142 | 144 |
| 145 | 155 | 166 |
| 47 | 59 | 70 |
| 74 | 76 | 77 |
| 90 | | |

Non Compliant Lever/knob Types

| | | |
|-----|-----|-----|
| 101 | 104 | 106 |
| 123 | 178 | 97 |
| 20 | | |

Handed Levers

| | | |
|----|-----|-----|
| 41 | 122 | 153 |
|----|-----|-----|

Refer to page 18 for detailed images of the levers and knobs that suit this range.

Handing

| | |
|--------------|---|
| Right Handed | R |
| Left Handed | L |

NB: Omit if non-handed

Finish

| | |
|-------------------------------------|-----|
| Antique Copper | AC |
| Architectural Bronze Unlacquered | AU |
| Chrome Plate | CP |
| Oil Rubbed Bronze | ORB |
| Polished Brass | PB |
| Polished Brass Unlacquered | BU |
| Polyester Powdercoat | PC* |
| Satin Brass | SB |
| Satin Chrome | SC |

Refer to the end of this catalogue for detailed images of all decorative finishes from this section.

4800 Series Narrow Plate Brass Door Furniture



A slimline, rectangular brass plate that adds style to your choice of lever.

Application

Designed for use with Lockwood Selector and Synergy Series short and standard backset mortice locks.

Additionally there are functions that are designed to work with Lockwood 3540 Series short backset mortice deadbolts.

Note: Certain lever designs are not compatible on short backset assemblies due to interference with the door stop. Refer to the backset suitability page at the end of this section.

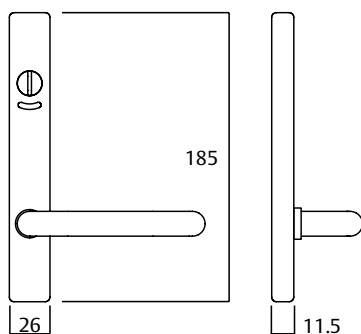

Product Details

Door Thickness

External plates are supplied with fixing screws to suit door thickness between 32 and 50mm. For thicker doors, please refer to the brass furniture thicker doors page at the end of this catalogue section.

Dimensions

185 x 26 x 11.5mm

Fixing

Plates are designed to fit back to back. If outside plate is specified with concealed fixing, then the inside plate must be visible fixed.

Handing

Plates are not handed; levers may be reversed by removing the stop screw, except for handed levers and functions as shown in the ordering procedure at the end of this section.

Decorative Finishes

Standard Finish:

Satin Chrome Brushed (SC)

Non Standard Finishes:

Chrome Plate (CP)
Polished Brass (PB)
Polyester Powdercoat (PC)*

Special Finishes:

Aged Brass (AG)
Architectural Bronze (AZ)
Architectural Bronze Unlaqured (AU)
Antique Copper (AC)
Oil Rubbed Bronze (ORB)
Polished Brass Unlaqured (BU)
Satin Brass (SB)
Satin Brass Unlacqured (SBU)

Turn Functions Adjustable Tailbar

Turn functions feature a unique mechanism that automatically adjusts the length of the tail bar to suit a particular door thickness.

* Refer to the end of this catalogue for detailed images of all decorative finishes that suit this range.

Standards and Compliance

4600 Series has been successfully tested up to 4 hours with a fire rated Lockwood mortice lock on fire door assemblies (depending on type of doorset) in accordance with Australian Standard AS1905.1:2005, Fire Resistant Doorsets.



4800 Series lever sets have been successfully tested to conform with Level D8 (500,000 cycles) under Australian Standard AS4145.2-2008, Locksets and hardware for doors and windows.

D8

4800 Series in brushed satin chrome finish has been successfully tested to conform with Level C10 (1000 hours) under Australian Standard AS4145.2-2008, Locksets and hardware for doors and windows.



4800 Series is designed, assembled and customised in Australia to suit the requirements of the Australian Market.

4800 Series includes levers and turns (as shown) that meet the requirements of AS1428.1-2009, Design for access and mobility.



4800 Series Plate Functions

Plates and Functions

(See page 17 and 18 for detailed ordering procedure table and part numbers)

To suit 3780 Series Mortice Locks

4800/4900

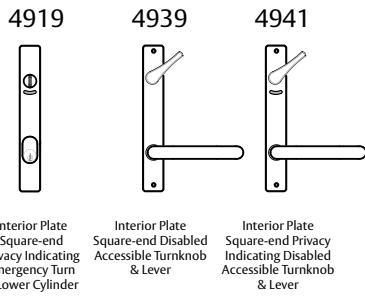
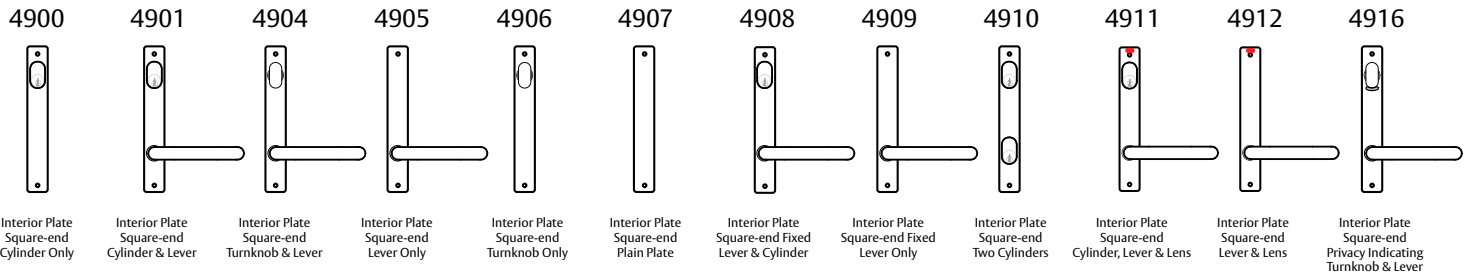
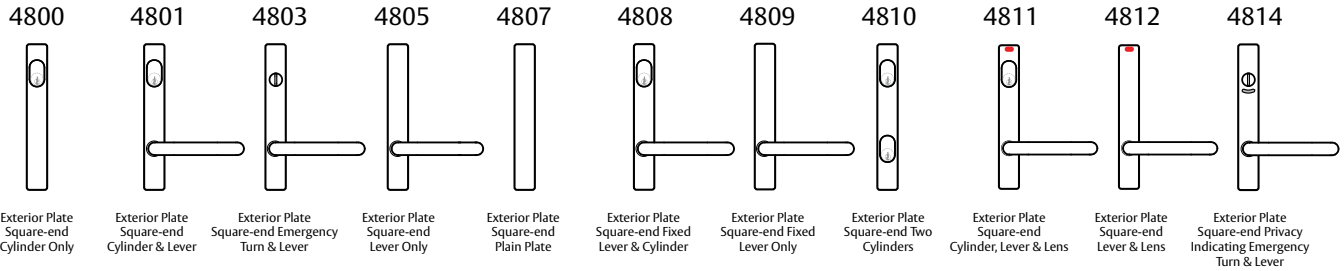





Note: Refer to page 18 for images of levers and knob styles available.

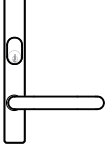
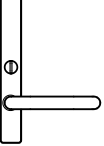
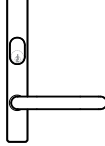
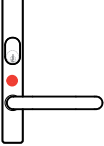
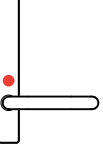

4800 Series Plate Functions

To suit 3770 & 3570 Series Mortice Locks 
4600/4700 (fire rated)

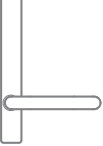
Functions 05, 07 & 09 use
 4800 / 4900 plate versions

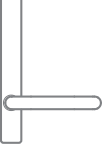
| | | | | | | |
|--|---|---|---|---|---|---|
| 4600 | 4601 | 4603 | 4608 | 4620 | 4622 | 4623 |
|  |  |  |  |  |  |  |
| Exterior Plate Square-end Cylinder Only | Exterior Plate Square-end Cylinder & Lever | Exterior Plate Square-end Emergency Turn & Lever | Exterior Plate Square-end Fixed Lever & Cylinder | Exterior Plate Square-end Cylinder, Lever & LED | Exterior Plate Square-end Lever & LED | Exterior Plate Square-end Cylinder & LED |

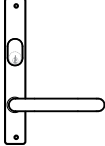
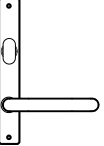
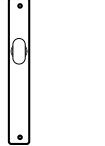
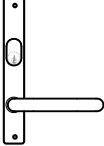
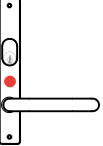
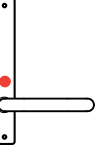
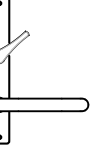
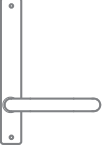
| | | |
|---|---|---|
| 4805 | 4807 | 4809 |
|  |  |  |
| Exterior Plate Square-end Lever Only | Exterior Plate Square-end Plain Plate | Exterior Plate Square-end Fixed Lever Only |

| | | | | | | | | | | |
|---|--|--|--|--|--|--|---|--|--|--|
| 4700 | 4701 | 4704 | 4706 | 4708 | 4720 | 4722 | 4739 | 4905 | 4907 | 4909 |
|  |  |  |  |  |  |  |  |  |  |  |
| Interior Plate Square-end Cylinder Only | Interior Plate Square-end Cylinder & Lever | Interior Plate Square-end Turnknob & Lever | Interior Plate Square-end Turnknob Only | Interior Plate Square-end Fixed Lever & Cylinder | Interior Plate Square-end Cylinder, Lever & LED | Interior Plate Square-end Lever & LED | Interior Plate Square-end Disabled Accessible Turnknob & Lever | Interior Plate Square-end Lever Only | Interior Plate Square-end Plain Plate | Interior Plate Square-end Fixed Lever Only |

To suit 3540 Series Motice Locks

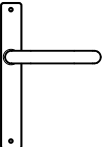
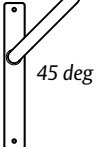
| | |
|--|---|
| 4980 | 4981 |
|  |  |
| Interior Plate Square-end Lever Only | Interior Plate Square-end Lever Angled Up 45° |

Note: Refer to page 18 for images of levers and knob styles available.

5800 Series Narrow Plate Brass Door Furniture



Functional, yet elegant, the soft lines of this round ended brass plate complement a wide range of levers.

Application

Designed for use with Lockwood Selector and Synergy Series short and standard backset mortice locks.

Additionally there are functions that are designed to work with Lockwood 3540 Series short backset mortice deadbolts.

Note: Certain lever designs are not compatible on short backset assemblies due to interference with the door stop. Refer to the backset suitability page at the end of this section.

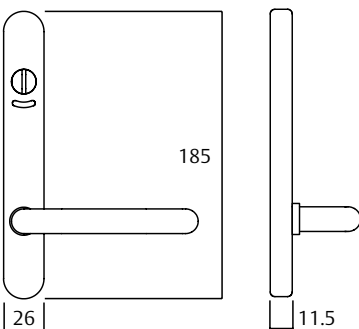

Product Details

Dimensions 185 x 26 x 11.5mm

Door Thickness External plates are supplied with fixing screws to suit door thickness between 32 and 50mm. For thicker doors, please refer to the brass furniture thicker doors page at the end of this catalogue section.

Fixing Plates are designed to fit back to back. If outside plate is specified with concealed fixing, then the inside plate must be visible fixed.

Handing Plates are not handed; levers may be reversed by removing the stop screw, except for handed levers and functions as shown in the ordering procedure at the end of this section.

Standard Finish:
Satin Chrome Brushed (SC)

Non Standard Finishes:
Chrome Plate (CP)
Polished Brass (PB)
Polyester Powdercoat (PC)*

Decorative Finishes:
Aged Brass (AG)
Architectural Bronze (AZ)
Architectural Bronze Unlaqured (AU)
Antique Copper (AC)
Oil Rubbed Bronze (ORB)
Polished Brass Unlaqured (BU)
Satin Brass (SB)
Satin Brass Unlacqured (SBU)

Turn Functions Adjustable Tailbar Turn functions feature a unique mechanism that automatically adjusts the length of the tail bar to suit a particular door thickness.

* Refer to the end of this catalogue for detailed images of all decorative finishes that suit this range.

Standards and Compliance

5600 Series has been successfully tested up to 4 hours with a fire rated Lockwood mortice lock on fire door assemblies (depending on type of doorset) in accordance with Australian Standard AS1905.1:2005, Fire Resistant Doorsets.



5800 Series lever sets have been successfully tested to conform with Level D8 (500,000 cycles) under Australian Standard AS4145.2-2008, Locksets and hardware for doors and windows.

D8

5800 Series in brushed satin chrome finish has been successfully tested to conform with Level C10 (1000 hours) under Australian Standard AS4145.2-2008, Locksets and hardware for doors and windows.



5800 Series is designed, assembled and customised in Australia to suit the requirements of the Australian Market.

5800 Series includes levers and turns (as shown) that meet the requirements of AS1428.1-2009, Design for access and mobility.



5800 Series Plate Functions

Plates and Functions

(See Page 17 and 18 for Detailed Ordering Procedure Table and Part Numbers)

To suit 3780 Series Mortice Locks

5800/5900

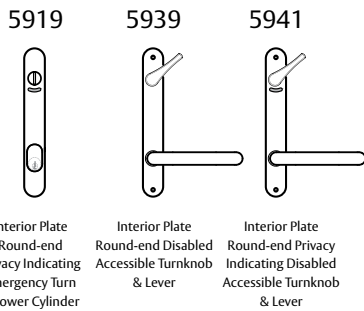
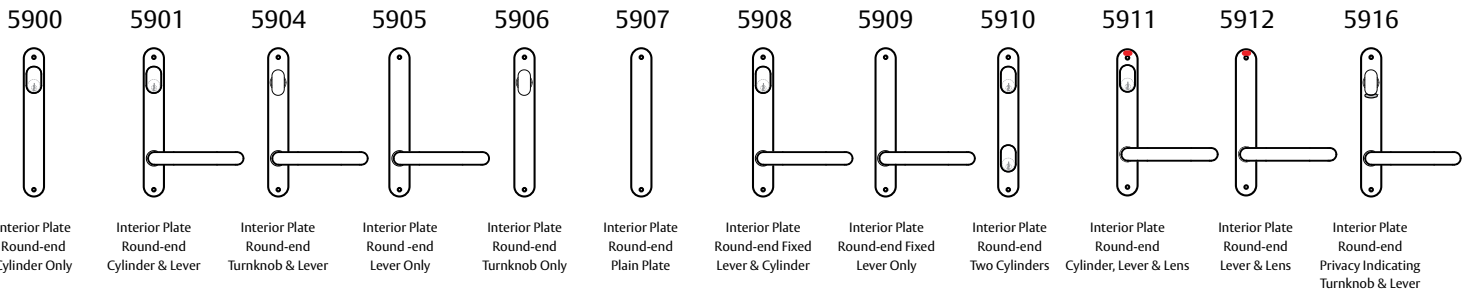
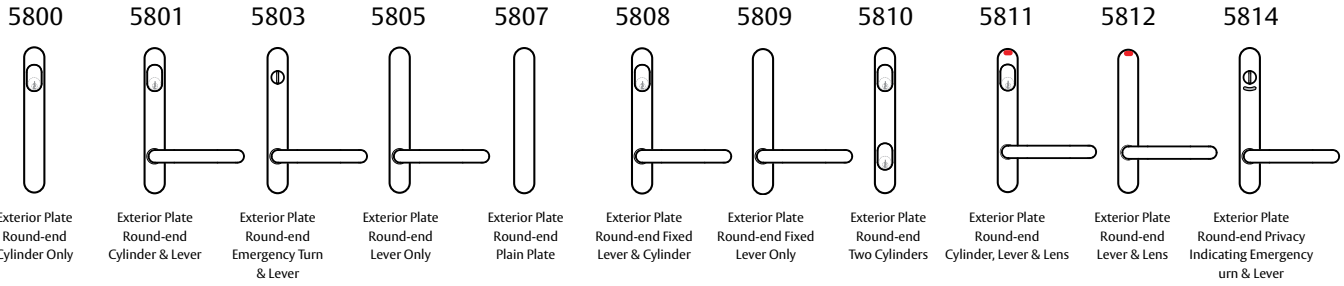

Note: Refer to page 18 for images of levers and knob styles available.

5800 Series Plate Functions

To suit 3770 & 3570 Series Mortice Locks 
5600/5700 (fire rated)

Functions 05, 07 & 09 use
 5800 / 5900 plate versions

| | | | | | | |
|--|---|---|---|--|--------------------------------------|---|
| 5600 | 5601 | 5603 | 5608 | 5620 | 5622 | 5623 |
| | | | | | | |
| Exterior Plate Round-end Cylinder Only | Exterior Plate Round-end Cylinder & Lever | Exterior Plate Round-end Emergency Turn & Lever | Exterior Plate Round-end Fixed Lever & Cylinder | Exterior Plate Round-end Cylinder, Lever & LED | Exterior Plate Round-end Lever & LED | Exterior Plate Round-end Cylinder & LED |

| | | |
|-------------------------------------|--------------------------------------|---|
| 5805 | 5807 | 5809 |
| | | |
| Exterior Plate Round-end Lever Only | Exterior Plate Round-end Plain Plate | Exterior Plate Round-end Fixed Lever Only |

| | | | | | | | | | | |
|--|---|---|--|---|--|--------------------------------------|---|-------------------------------------|--------------------------------------|---|
| 5700 | 5701 | 5704 | 5706 | 5708 | 5720 | 5722 | 5739 | 5905 | 5907 | 5909 |
| | | | | | | | | | | |
| Interior Plate Round-end Cylinder Only | Interior Plate Round-end Cylinder & Lever | Interior Plate Round-end Turnknob & Lever | Interior Plate Round-end Turnknob Only | Interior Plate Round-end Fixed Lever & Cylinder | Interior Plate Round-end Cylinder, Lever & LED | Interior Plate Round-end Lever & LED | Interior Plate Round-end Disabled Accessible Turnknob & Lever | Interior Plate Round-end Lever Only | Interior Plate Round-end Plain Plate | Interior Plate Round-end Fixed Lever Only |

To suit 3540 Series Mortice Locks

| | |
|-------------------------------------|--|
| 5980 | 5981 |
| | |
| Interior Plate Round-end Lever Only | Interior Plate Round-end Lever Angled Up 45° |

Note: Refer to page 18 for images of levers and knob styles available.

4800 & 5800 Series Ordering Procedure

Example:

Sample part number 4801/53LCP is made up of several selections. Choose your product by selecting an option from each section.

Ordering procedure for door furniture to be used with Selector Series Mortice Locks 3770 and 3780 and for use with Synergy Series Mortice Locks 3570.

| Plate Type | Plate Function | Lever Type | Handing | Finish |
|------------|----------------|------------|---------|--------|
| 48 | 01 | 53 | L | CP |

| Plate Type | |
|--|----|
| Standard backset mortice locks 3570 Series (Synergy) and 3770 Series (Selector) | |
| Exterior Square End | 46 |
| Interior Square End | 47 |
| Exterior Round End | 56 |
| Interior Round End | 57 |
| Short backset mortice locks 3780 Series (Selector) | |
| Exterior Square End | 48 |
| Interior Square End | 49 |
| Exterior Round End | 58 |
| Interior Round End | 59 |

| Plate Function | |
|------------------------|----|
| Cylinder Only | 00 |
| Cylinder & Lever | 01 |
| Emergency Turn & Lever | 03 |
| Turnknob & Lever | 04 |
| Lever Only | 05 |
| Turnknob Only | 06 |
| Plain Plate | 07 |
| Two Cylinders | 10 |

| Plate Functions - 3570EL Series Synergy Electric Mortice Locks only | |
|---|----|
| Cylinder, Lever & LED | 20 |
| Lever & LED | 22 |
| Cylinder & LED | 23 |
| Disabled Accessible Turnknob & Lever | 39 |

| Plate Functions - 3780 Series Mortice Lock only | |
|---|----|
| Privacy Indicating Emergency Turn & Lever | 14 |
| Privacy Indicating Turnknob & Lever | 16 |
| Privacy Indicating Turnknob & Lower Cylinder | 19 |
| Privacy Indicating Disabled Accessible Turnknob & Lever | 41 |

| Plate Function - Handed | |
|-----------------------------|----|
| Fixed Lever & Cylinder | 08 |
| Fixed Lever Only | 09 |
| Cylinder, Fixed Lever & LED | 21 |

| Plate Functions - 3780EL Series Selector Electric Mortice Locks only | |
|--|----|
| Cylinder, Lever and Lens | 11 |
| Lever & Lens | 12 |

| AS1428.1 Compliant Lever Types | | |
|--------------------------------|-----|-----|
| 102 | 111 | 112 |
| 115 | 116 | 118 |
| 124 | 131 | 132 |
| 133 | 142 | 144 |
| 145 | 155 | 166 |
| 47 | 59 | 70 |
| 74 | 76 | 77 |
| 90 | | |

| Non Compliant Lever/Knob Types | | |
|--------------------------------|-----|-----|
| 101 | 104 | 106 |
| 123 | 178 | 97 |
| 20 | | |

| Handed Levers | | |
|---------------|-----|-----|
| 41 | 122 | 153 |

Notes: Certain lever designs are not compatible on short backset assemblies. See page 17 for specific lever design suitability details.

Refer to page 18 for detailed images of the levers and knobs that suit this range.

| Handing | |
|--------------|---|
| Right Handed | R |
| Left Handed | L |

NB: Omit if non-handed

| Finish | |
|----------------------------------|-----|
| Aged Brass | AG |
| Architectural Bronze | AZ |
| Architectural Bronze Unlacquered | AU |
| Antique Copper | AC |
| Chrome Plate | CP |
| Oil Rubbed Bronze | ORB |
| Polished Brass | PB |
| Polished Brass Unlacquered | BU |
| Polyester Powdercoat | PC* |
| Satin Brass | SB |
| Satin Chrome | SC |
| Satin Brass Unlacquered | SBU |

* Refer to the end of this catalogue for detailed images of all decorative finishes from this section.

4800 & 5800 Series Ordering Procedure

Ordering procedure for door furniture to be used with 3540 Series Mortice Locks

| Plate Type | Plate Function | Lever Type | Finish |
|------------|----------------|------------|--------|
| 48 | 80 | 70 | SC |

| Platform Name | |
|---------------------|----|
| Exterior Square End | 48 |
| Interior Square End | 49 |
| Exterior Round End | 58 |
| Interior Round End | 59 |

| Plate Function | |
|-----------------------|----|
| Lever Only | 80 |
| Lever - Angled Up 45° | 81 |

| Lever Type | |
|----------------------------------|----|
| 67 | |
| AS1428.1 Compliant Levers | |
| 70 | 77 |

Note: Certain lever designs are not compatible on short backset assemblies. See page 17 for specific lever design suitability details.

See page 18 for details on lever images and dimensions.

| Finish | |
|----------------------------------|-----|
| Aged Brass | AG |
| Architectural Bronze | AZ |
| Architectural Bronze Unlacquered | AU |
| Antique Copper | AC |
| Chrome Plate | CP |
| Oil Rubbed Bronze | ORB |
| Polished Brass | PB |
| Polished Brass Unlacquered | BU |
| Polyester Powdercoat | PC |
| Satin Brass | SB |
| Satin Brass Unlacquered | SBU |
| Satin Chrome | SC |

* Refer to the end of this catalogue for detailed images of all decorative finishes from this section.

4800 & 5800 Series Lever Suitability

Application

All narrow style door furniture will be closer to the door frame. Lever handles with 90 degree angles can cause the lever stem to hit the door frame and prevent the door from opening. The table below provides a guide to lever compatibility and each model of short backset lock from 3782 to 6782. Based on 12mm doorstop.

| Lever Number | 3782 3540 23mm | 4782 25.4 | 5782 30mm | 6782 38mm |
|--------------|----------------------|--------------|--------------|--------------|
| 41 | X | X | ✓ | ✓ |
| 59 | X | X | ✓ | ✓ |
| 70 | ✓ | ✓ | ✓ | ✓ |
| 74 | X | X | ✓ | ✓ |
| 76 | X | X | ✓ | ✓ |
| 77 | ✓ | ✓ | ✓ | ✓ |
| 90 | X | X | ✓ | ✓ |
| 97 | ✓ | ✓ | ✓ | ✓ |
| 101 | X | X | ✓ | ✓ |
| 102 | ✓ | ✓ | ✓ | ✓ |
| 104 | X | ✓ | ✓ | ✓ |
| 106 | X | X | ✓ | ✓ |
| 111 | X | X | ✓ | ✓ |
| 112 | X | X | ✓ | ✓ |
| 115 | ✓ | ✓ | ✓ | ✓ |
| 116 | X | X | ✓ | ✓ |
| 118 | X | X | ✓ | ✓ |
| 122 | X | X | ✓ | ✓ |
| 122 | X | X | ✓ | ✓ |
| 123 | X | X | ✓ | ✓ |
| 124 | X | X | ✓ | ✓ |
| 131 | X | X | ✓ | ✓ |
| 132 | X | X | ✓ | ✓ |
| 133 | X | X | ✓ | ✓ |
| 144 | X | ✓ | ✓ | ✓ |
| 145 | X | X | ✓ | ✓ |
| 153 | X | X | ✓ | ✓ |
| 155 | X | ✓ | ✓ | ✓ |
| 166 | X | X | ✓ | ✓ |
| 178 | X | X | ✓ | ✓ |
| 180 | X | ✓ | ✓ | ✓ |

Brass Levers and Knobs

BRASS CORE

For use on the following door furniture series:

- 1220 Series
- 1420 Series
- 1360 Series
- 1370 Series
- 1800 Series
- 2800 Series
- 4800 Series
- 5800 Series
- Artefact Series

AS1428.1 Compliant Levers

| Lever 102 | |
|-------------------|---------|
| Length | 134.3mm |
| Projection | 57.5mm |

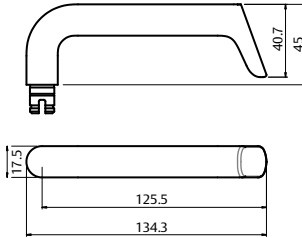

| Lever 111 | |
|-------------------|--------|
| Length | 130mm |
| Projection | 48.5mm |

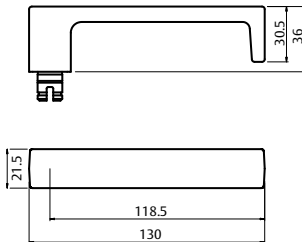

| Lever 112 | |
|-------------------|---------|
| Length | 130.5mm |
| Projection | 48mm |

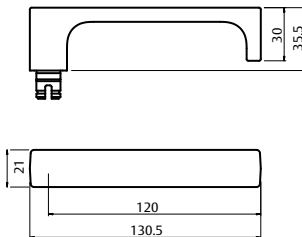

Brass Levers and Knobs

AS1428.1 Compliant Levers

Lever 115

| | |
|-------------------|---------|
| Length | 140.4mm |
| Projection | 60mm |

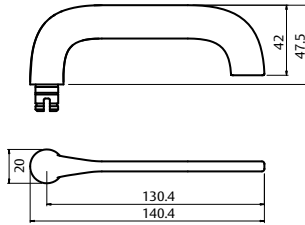

Lever 116

| | |
|-------------------|---------|
| Length | 140.5mm |
| Projection | 47.6mm |

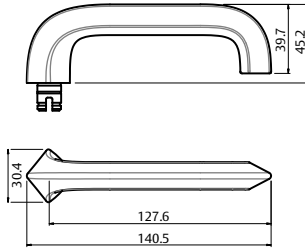

Lever 118

| | |
|-------------------|-------|
| Length | 128mm |
| Projection | 58mm |

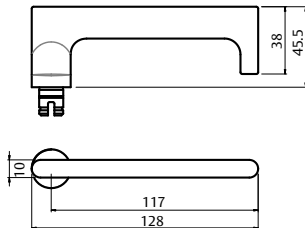

Lever 124

| | |
|-------------------|---------|
| Length | 130.5mm |
| Projection | 59mm |

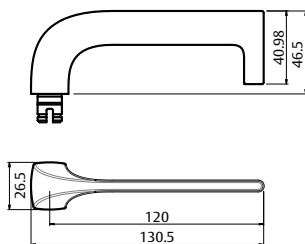

Brass Levers and Knobs

AS1428.1 Compliant Levers

Lever 131

| | |
|-------------------|---------|
| Length | 134.5mm |
| Projection | 53mm |

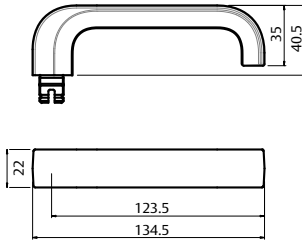

Lever 132

| | |
|-------------------|--------|
| Length | 130mm |
| Projection | 57.5mm |

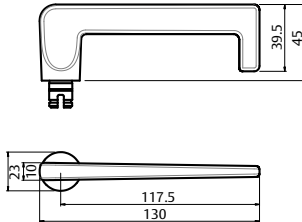

Lever 133

| | |
|-------------------|--------|
| Length | 130mm |
| Projection | 53.5mm |

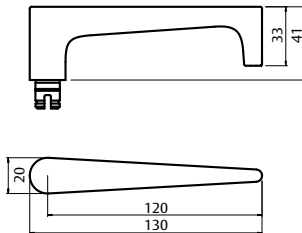

Lever 142

| | |
|-------------------|---------|
| Length | 130.5mm |
| Projection | 55mm |

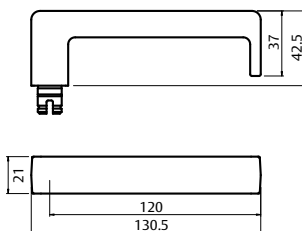

Brass Levers and Knobs

AS1428.1 Compliant Levers

Lever 144

| | |
|-------------------|---------|
| Length | 128.8mm |
| Projection | 57.5mm |

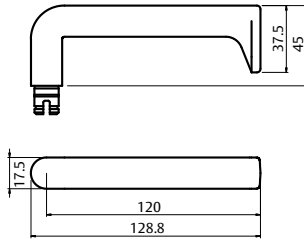

Lever 145

| | |
|-------------------|--------|
| Length | 130mm |
| Projection | 58.5mm |

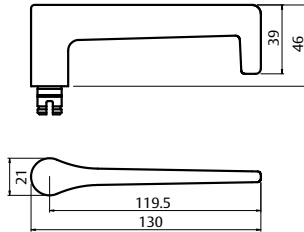

Lever 155

| | |
|-------------------|---------|
| Length | 129.3mm |
| Projection | 57.5mm |

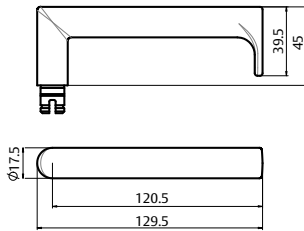

Lever 166

| | |
|-------------------|-------|
| Length | 130mm |
| Projection | 48mm |

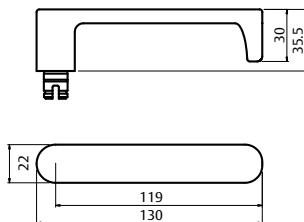

Brass Levers and Knobs

AS1428.1 Compliant Levers

Lever 47

| | |
|-------------------|--------|
| Length | 120mm |
| Projection | 49.6mm |

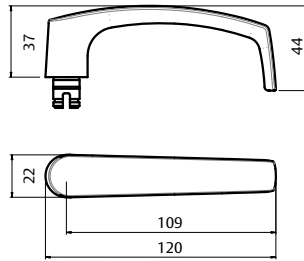

Lever 59

| | |
|-------------------|--------|
| Length | 121mm |
| Projection | 57.5mm |

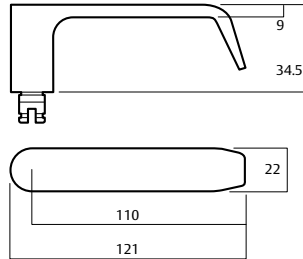

Lever 70

| | |
|-------------------|-------|
| Length | 121mm |
| Projection | 53mm |

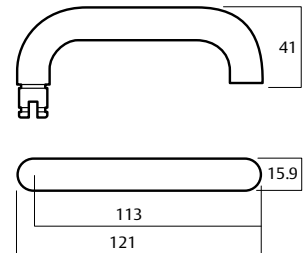

Lever 74

| | |
|-------------------|-------|
| Length | 120mm |
| Projection | 53mm |

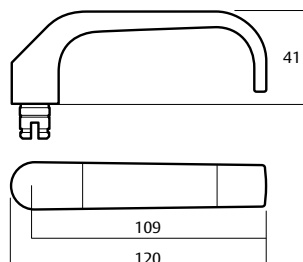

Brass Levers and Knobs

AS1428.1 Compliant Levers

Lever 76

| | |
|-------------------|--------|
| Length | 125mm |
| Projection | 48.5mm |

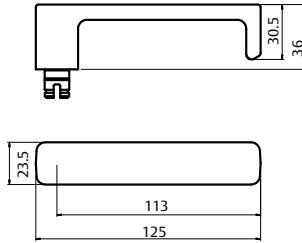

Lever 77

| | |
|-------------------|-------|
| Length | 121mm |
| Projection | 51mm |

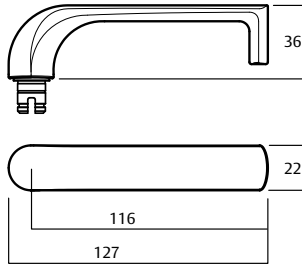

Lever 90

| | |
|-------------------|---------|
| Length | 118.5mm |
| Projection | 52mm |

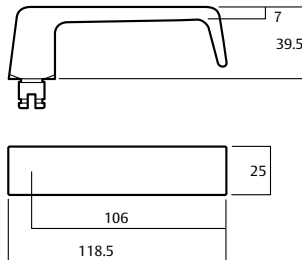

Brass Levers and Knobs

Non compliant lever/knob types

Lever 101

| | |
|-------------------|--------|
| Length | 130mm |
| Projection | 48.5mm |

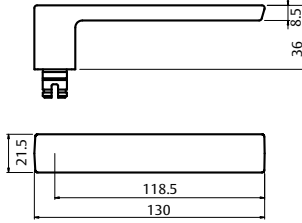

Lever 104

| | |
|-------------------|---------|
| Length | 133.8mm |
| Projection | 57.5mm |

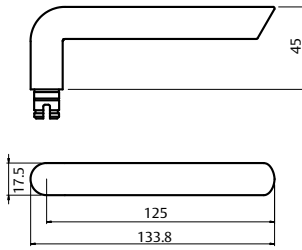

Lever 106

| | |
|-------------------|-------|
| Length | 130mm |
| Projection | 48mm |

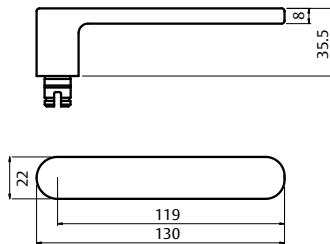

Lever 123

| | |
|-------------------|---------|
| Length | 130.5mm |
| Projection | 59mm |

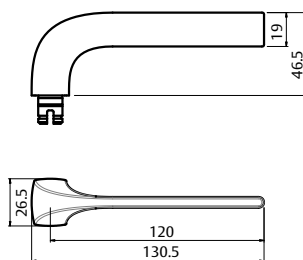

Brass Levers and Knobs

Non compliant lever/knob types

Lever 178

| | |
|-------------------|--------|
| Length | 130mm |
| Projection | 63.6mm |

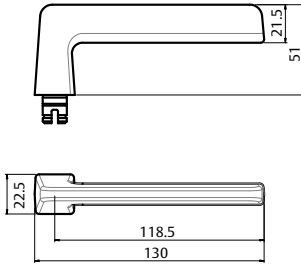

Lever 97

| | |
|-------------------|--------|
| Length | 120mm |
| Projection | 50.5mm |

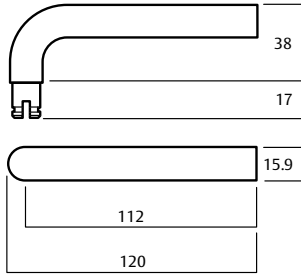

Knob 20

| | |
|-------------------|------|
| Diameter | 50mm |
| Projection | 73mm |

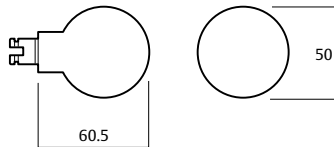

Not compatible with 1220 Symphony internal rose.

Brass Levers and Knobs

Handed Levers

Lever 41

| | |
|-------------------|--------|
| Length | 130mm |
| Projection | 61.5mm |

* Lever is an asymmetrical design and therefore must be handed.

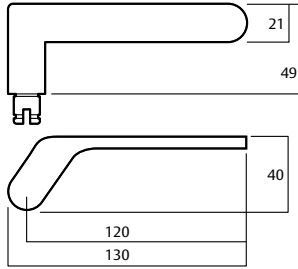

Lever 122

| | |
|-------------------|---------|
| Length | 130.5mm |
| Projection | 59mm |

* Lever is an asymmetrical design and therefore must be handed.

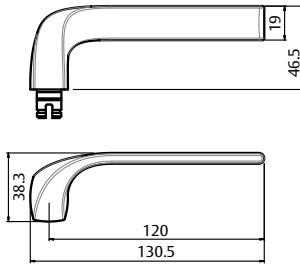

Lever 153

| | |
|-------------------|--------|
| Length | 120mm |
| Projection | 70.6mm |

* Lever is asymmetrically designed and therefore must be handed

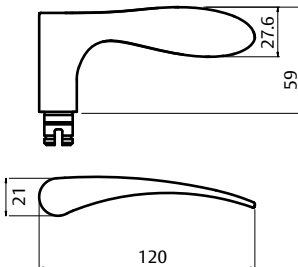

200 Series Artefact Square Corner Plate Furniture



The 200 Series Door Furniture Plates measure 162x162mm, and feature square corners. Concealed fixed plates have studs with internal threads located in each corner, visible fixed plates have corresponding countersunk holes and are fixed back to back through the door.

Application

Designed for use with Lockwood Selector 3770 and Synergy 3570 Series Mortice Locks; Latches and Push and Pull doors.

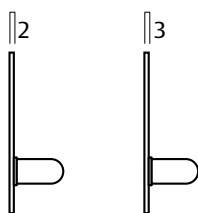
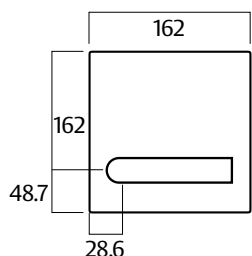

SS/Brass Aluminium

Product Details

| | |
|------------------------------|--|
| Dimensions | 162 x 162 x 3mm - aluminium 162 x 162 x 2mm - stainless steel and brass |
| Door Thickness | 35 to 45mm standard. For doors 45 to 55mm thick, specify long fixing screws SP2000-208. |
| Standard Finishes | Natural Anodised Aluminium (NT) Satin Stainless Steel (SS) |
| Fixing | Plates are designed to fit back to back. If outside plate is specified with concealed fixing, then the inside plate must be visible fixed. |
| Finishes Non Standard | 316 Marine Grade (MG) Polished Brass (PB) Polished Stainless Steel (PS) Powdercoat (PC)* |
| Handing | All plates are handed with the exception of plain plates and pull handles. |
| Materials | Aluminium, brass and stainless steel |

Note: When using flush pulls back to back the minimum door thickness is 40mm.

* Refer to the end of this catalogue for detailed images of all decorative finishes that suit this range.

Standards and Compliance



Artefact 200 Series has been successfully tested up to 4 hours with a fire rated Lockwood mortice lock on fire door assemblies (depending on type of doorset) in accordance with Australian Standard AS1905.1:2005, Fire Resistant Doorsets.

Artefact 200 Series lever sets have been successfully tested to conform with Level D8 (500,000 cycles) under Australian Standard AS4145.2-2008, Locksets and hardware for doors and windows.

D8



Anti-Corrosion



Artefact 200 Series includes levers and turns (as shown) that meet the requirements of AS1428.1-2009, Design for access and mobility.

Lockwood Artefact Series is designed, assembled and customised in Australia to suit the requirements of the Australian Market.

200 Series Levers and Functions

Levers and Knob to Suit

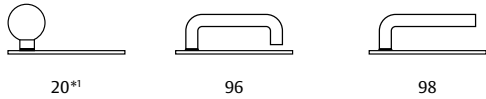

For lever images and dimensions, see page 15.

*1 Stainless Steel Only

Pull Handle to Suit

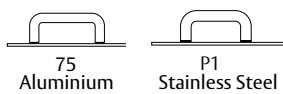

Plates

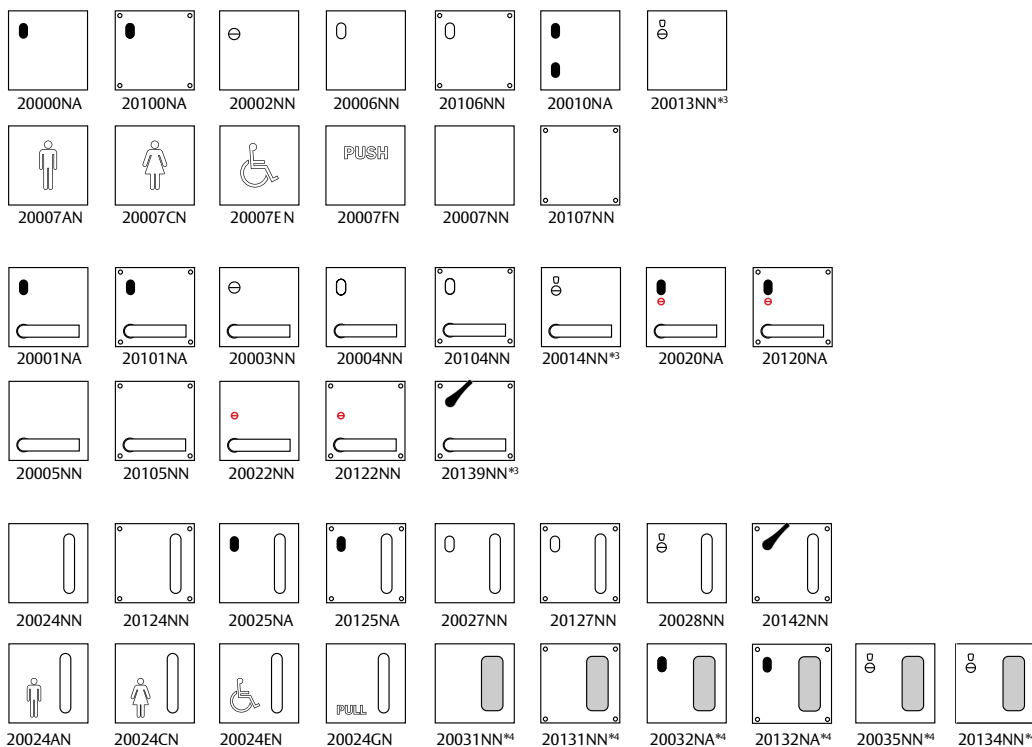

*3 Replace NN with NS when ordering with 3770 Series

*4 Recommended for sliding doors only

Plates and Functions Legend

| | | | | | |
|---------------|--|-------------------|--|---------------------------|--|
| Cylinder Hole | | Emergency Turn | | LED | |
| Turnknob | | Disabled Turnknob | | Indicating Emergency Turn | |

202 Series Artefact Round Corner Plate Furniture



The 202 Series Door Furniture is 162mm square with 10mm radius corners. Concealed fixed plates have studs with internal threads located in each corner, visible fixed plates have corresponding countersunk holes and are fixed back to back through the door.

Application

Designed for use with Lockwood Selector 3770 and Synergy 3570 Series Mortice Locks; Latches and Push and Pull doors.

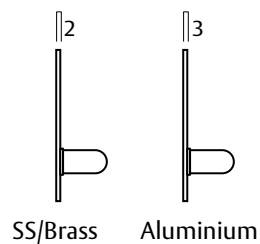
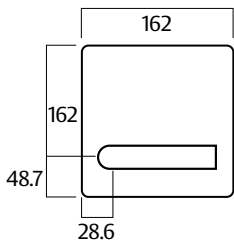

Product Details

| | |
|------------------------------|--|
| Dimensions | 162 x 162 x 3mm - aluminium 162 x 162 x 2mm - stainless steel and brass |
| Door Thickness | 35 to 45mm standard. For doors 45 to 55mm thick, specify long fixing screws SP2000-208. |
| Fixing | Plates are designed to fit back to back. If outside plate is specified with concealed fixing, then the inside plate must be visible fixed. |
| Standard Finishes | Natural Anodised Aluminium (NT) Satin Stainless Steel (SS) |
| Finishes Non Standard | 316 Marine Grade (MG) Polished Brass (PB) Polished Stainless Steel (PS) Powdercoat (PC)* |
| Handing | All plates are handed with the exception of plain plates and pull handles. |
| Materials | Aluminium, brass and stainless steel |

Note: When using flush pulls back to back the minimum door thickness is 40mm.

* Refer to the end of this catalogue for detailed images of all decorative finishes that suit this range.

Standards and Compliance



Artefact 202 Series has been successfully tested up to 4 hours with a fire rated Lockwood mortice lock on fire door assemblies (depending on type of doorset) in accordance with Australian Standard AS1905.1:2005, Fire Resistant Doorsets.

Artefact 202 Series lever sets have been successfully tested to conform with Level D8 (500,000 cycles) under Australian Standard AS4145.2-2008, Locksets and hardware for doors and windows.

D8



Anti-Corrosion



Artefact 202 Series includes levers and turns (as shown) that meet the requirements of AS1428.1-2009, Design for access and mobility.

Lockwood Artefact Series is designed, assembled and customised in Australia to suit the requirements of the Australian Market.

202 Series Levers and Functions

Levers and Knob to Suit

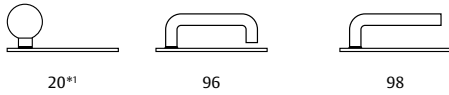

For lever images and dimensions, see page 15.

*1 Stainless Steel Only

Pull Handle to Suit

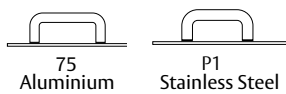

Plates

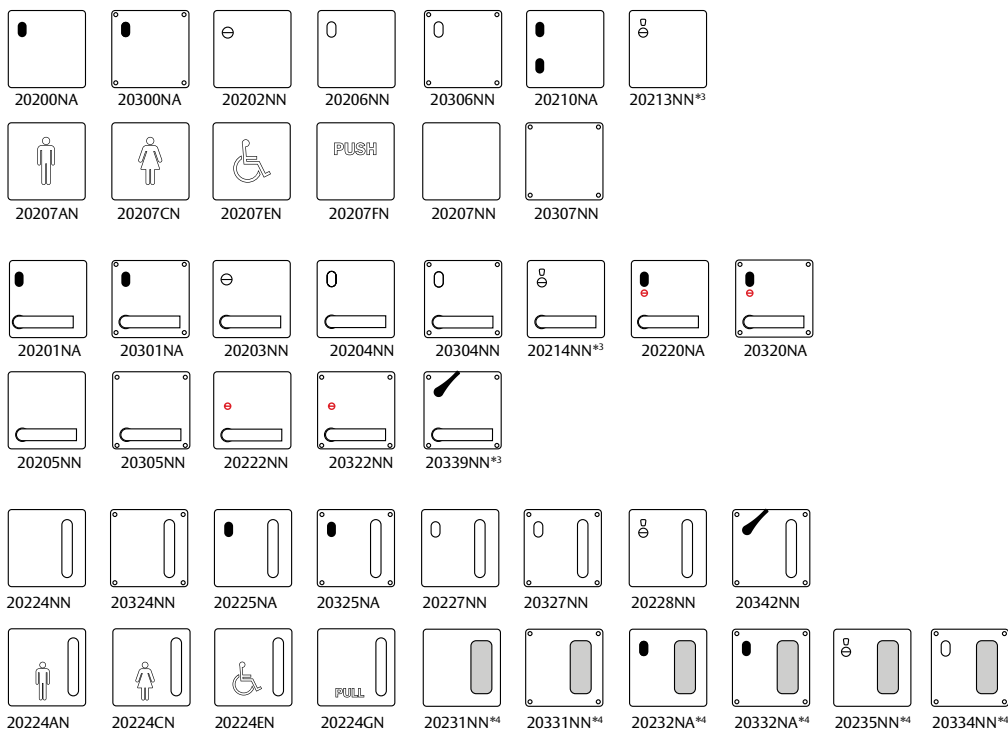

*3 Replace NN with NS when ordering with 3770 Series

*4 Recommended for sliding doors only

Plates and Functions Legend

| | | | | | |
|---------------|--|-------------------|--|---------------------------|--|
| Cylinder Hole | | Emergency Turn | | LED | |
| Turnknob | | Disabled Turnknob | | Indicating Emergency Turn | |

200/202 Series Ordering Procedure

When ordering 13, 14, 16 or 39 functions with 3770 series, specify "S" in cylinder type instead of "N".

Sample part number 20001NA/96LSS is made up of several sections. Choose your product by selecting an option from each section.

| Plate Type | Plate Function | Engraving | Cylinder Type | Lever/Knob/Pull Handle | Handing | Finish |
|------------|----------------|-----------|---------------|------------------------|---------|--------|
| 200 | 01 | N | A | 96 | L | SS |

| Plate Type | Plate Function | Engraving - Handed | AS1428.1 Compliant Lever Types | Finish | |
|--|---|--|---|--|---|
| Exterior Plate (162 x 162) – Square Corners 200 | Plain Plate 07 Pull Handle Only 24 | A – G Outlined Infill R – X Full Infill | 102 111 112 115 116 118 124 131 132 133 142 144 145 155 166 47 59 70 74 76 77 90 | Stainless Steel Finishes 316 Marine Grade MG Powdercoat PC Polished Stainless Steel PS Satin Stainless Steel SS | |
| Interior Plate (162 x 162) – Square Corners 201 | Plate Function - Handed | Male symbol A R Male text B S Female symbol C T Female text D U Disabled symbol E V Push text F W Pull text G X Unisex symbol H Y No option N | Non Compliant Lever/Knob Types 101 104 106 123 178 97 20 | Aluminium Finishes Natural Anodised NT* | |
| Exterior Plate (162 x 162) – Radius Corners 202 | Cylinder Only 00 Cylinder & Lever 01 Emergency Turn Only 02 Emergency Turn & Lever 03 Turnknob & Lever 04 Lever Only 05 Turnknob Only 06 Cylinder & Fixed Lever 08 Fixed Lever Only 09 Dual Cylinder 10 Privacy Indicating Emergency Turn Only 13 Privacy Indicating Emergency Turn & Lever 14 Privacy Indicating Turnknob & Lever 16 Cylinder, Lever & LED 20 Cylinder, Fixed Lever & LED 21 Lever & LED 22 Cylinder & LED 23 Pull Handle & Cylinder 25 Pull Handle & Emergency Turn 26 Pull Handle & Turnknob 27 Pull Handle & Privacy Indicating Emergency Turn 28 Pull Handle & Dual Cylinder 30 Flush Pull Only 31 Flush Pull & Cylinder 32 Flush Pull & Emergency Turn 33 Flush Pull & Turnknob 34 Flush Pull & Privacy Indicator Emergency Turn 35 Flush Pull & Dual Cylinder 37 Disabled Turnknob & Lever 39 Pull Handle & Disabled Turnknob 42 | Cylinder Type Oval Cylinder – 32mm (H) x 18mm (W) Lockwood 570 Cylinders A Guarded Oval Cylinder – 32mm (H) x 18mm (W) Lockwood 570 Cylinders B No Cylinder Function – Selector S* No Cylinder Function – Synergy N | Handed Levers 41 122 153 | Brass Finishes Polished Brass PB | |
| Interior Plate (162 x 162) – Radius Corners 203 | | <i>For all in-filled engraving, black gloss is the standard.</i> | | Pull Handles P1 P1*1 75*2 Pull Handles - Horizontal HP1 HP1*1 H75*2 | <i>* Refer to the end of this catalogue for detailed images of all decorative finishes from this section.</i> |
| | | | | Handles are brass unless indicated otherwise *1 = Stainless Steel *2 = Aluminium *3 = 316 Marine Grade ** Lever 65 and 85 not available in PS or PB | |
| | | | | Handing Left Handed L Right Handed R | |

212 Series Artefact Oval Plate Furniture



The 212 Series Door Furniture is 162mm long x 50mm wide with radius ends. Concealed fixed plates have studs with internal threads located top and bottom, visible fixed plates have corresponding countersunk holes and are fixed back to back through the door.

Application

Designed for use with Selector 3770 and Synergy 3570 Series Mortice Locks.

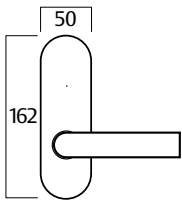

SS/Brass



Aluminium

Product Details

Dimensions 162 x 50 x 3mm - aluminium
162 x 50 x 2mm - stainless steel and brass

Materials Aluminium, stainless steel or brass

Door Thickness 35 to 45mm standard. For doors 45 to 55mm thick, specify long fixing screws SP2000-208.

Standard Finishes Natural Anodised Aluminium (NT)
Stainless Steel (SS)

Non Standard Finishes 316 Marine Grade (MG)
Polished Brass (PB)
Polished Stainless Steel (PS)
Powdercoat (PC)

Standards and Compliance



Artefact 212 Series has been successfully tested up to 4 hours with a fire rated Lockwood mortice lock on fire door assemblies (depending on type of doorset) in accordance with Australian Standard AS1905.1:2005, Fire Resistant Doorsets.

Artefact 212 Series lever sets have been successfully tested to conform with Level D8 (500,000 cycles) under Australian Standard AS4145.2-2008, Locksets and hardware for doors and windows.

D8



Anti-Corrosion.



Artefact 212 Series includes levers and turns (as shown) that meet the requirements of AS1428.1-2009, Design for access and mobility.

Lockwood Artefact Series is designed, assembled and customised in Australia to suit the requirements of the Australian Market.

212 Series Levers and Functions

Levers and Knob to Suit

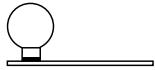

20*1

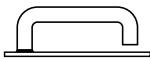

96

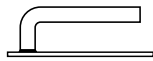

98

For lever images and dimensions, see page 15.

*1 Stainless Steel Only

Pull Handle to Suit

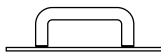

75
Aluminium

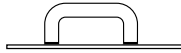

P1
Stainless Steel

Plates



21200NA

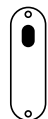

21300NA



21202NN

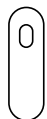

21206NN

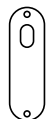

21306NN



21207NN



21307NN



21210NA

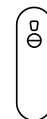

21213NN*3

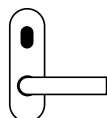

21201NA

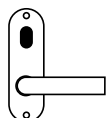

21301NA

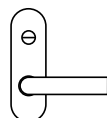

21203NN

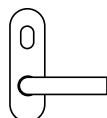

21204NN

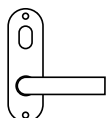

21304NN

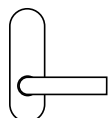

21205NN

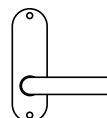

21305NN

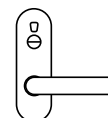

21214NN*3

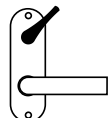

21339NN*3

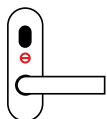

21220NA

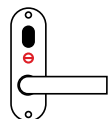

21320NA

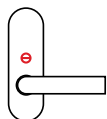

21222NN

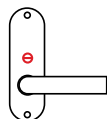

21322NN

*3 Replace NN with NS when ordering with 3770 Series

Plates and Functions Legend

Cylinder Hole



Emergency Turn



LED



Turnknob



Disabled Turnknob



Indicating Emergency Turn



224 Series Artefact Rectangular Plate Furniture

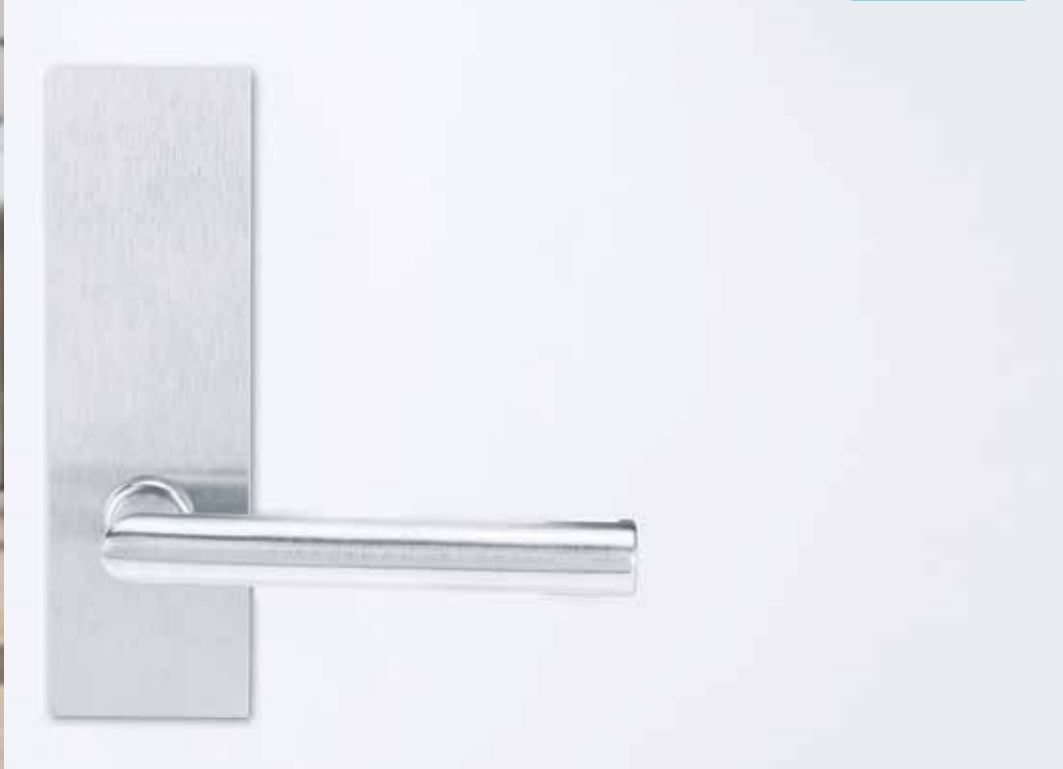

The 224 Series Door Furniture is 162mm long x 50mm wide with square ends. Concealed fixed plates have studs with internal threads located top and bottom, visible fixed plates have corresponding countersunk holes and are fixed back to back through the door.

Application

Designed for use with Selector 3770 and Synergy 3570 Series Mortice Locks.

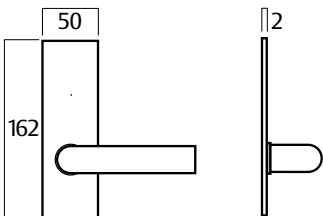

Product Details

| | |
|-----------------------|--|
| Dimensions | 162 x 50 x 2mm - stainless steel |
| Materials | Stainless steel only |
| Door Thickness | 35mm to 45mm as supplied. Maximum 65mm. For thicker door parts, see page 53. |
| Finishes | Stainless Steel (SS) |

Standards and Compliance



Artefact 224 Series has been successfully tested up to 4 hours with a fire rated Lockwood mortice lock on fire door assemblies (depending on type of doorset) in accordance with Australian Standard AS1905.1:2005, Fire Resistant Doorsets.

Artefact 224 Series lever sets have been successfully tested to conform with Level D8 (500,000 cycles) under Australian Standard AS4145.2-2008, Locksets and hardware for doors and windows.

D8



Anti-Corrosion.



Artefact 224 Series includes levers and turns (as shown) that meet the requirements of AS1428.1-2009, Design for access and mobility.

Lockwood Artefact Series is designed, assembled and customised in Australia to suit the requirements of the Australian Market.

224 Series Levers and Functions

Levers and Knob to Suit

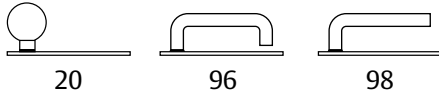

For lever images and dimensions, see page 15.

Pull Handle to Suit

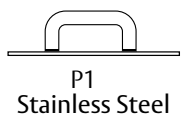

Plates

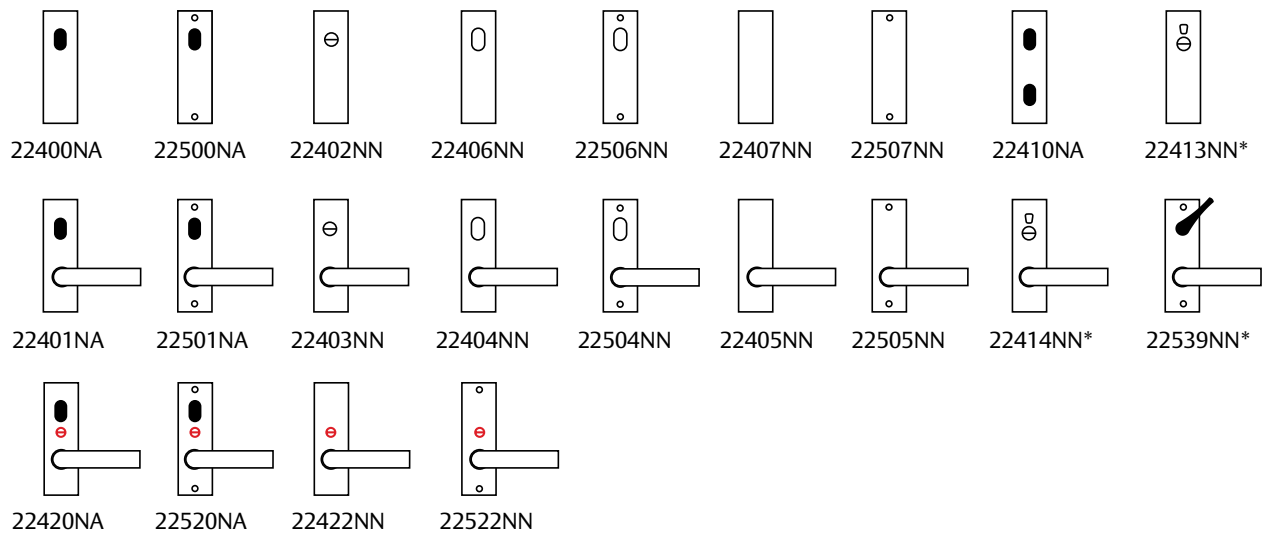

* Replace NN with NS when ordering with 3770 Series

Plates and Functions Legend

| | | | | | |
|---------------|--|-------------------|--|---------------------------|--|
| Cylinder Hole | | Emergency Turn | | LED | |
| Turnknob | | Disabled Turnknob | | Indicating Emergency Turn | |

212/224 Series Ordering Procedure

When ordering 13, 14, 16 or 39 functions with 3770 series, specify "S" in cylinder type instead of "N".

Sample part number 21201NA/96LSS is made up of several sections. Choose your product by selecting an option from each section.

| Plate Type | Plate Function | Engraving | Cylinder Type | Lever/Knob/Pull Handle | Handing | Finish |
|------------|----------------|-----------|---------------|------------------------|---------|--------|
| 212 | 01 | N | A | 96 | L | SS |

| Plate Type | Plate Function | Engraving - Handed | AS1428.1 Compliant Lever Types | Finish |
|--|---|--|---------------------------------------|---|
| Exterior Plate (162 x 50) - Oval 212 | Cylinder Only 00 | A - G Outlined Infill R - X Full Infill | 102 111 112 | Stainless Steel Finishes |
| Interior Plate (162 x 50) - Oval 213 | Cylinder & Lever 01 | Male symbol A R | 115 116 118 | 316 Marine Grade MG |
| Exterior Plate (162 x 50) - Rectangular 224 | Emergency Turn Only 02 | Male text B S | 124 131 132 | Powdercoat PC |
| Interior Plate (162 x 50) - Rectangular 225 | Emergency Turn & Lever 03 | Female symbol C T | 133 142 144 | Polished Stainless Steel PS |
| | Turnknob & Lever 04 | Female text D U | 145 155 166 | Satin Stainless Steel SS |
| | Lever Only 05 | Disabled symbol E V | 47 59 70 | Aluminium Finishes⁴ |
| | Turnknob Only 06 | Push text F W | 74 76 77 | Natural Anodised NT |
| | Plain Plate 07 | Pull text G X | 78 90 | Brass Finishes⁴ |
| | Dual Cylinder 10 | Unisex symbol H Y | | Polished Brass PB |
| | Privacy Indicating Emergency Turn Only 13 | No option N | | |
| | Privacy Indicating Emergency Turn & Lever 14 | <i>For all in-filled engraving, black gloss is the standard.</i> | | <i>* Refer to the end of this catalogue for detailed images of all decorative finishes from this section.</i> |
| | Privacy Indicating Turnknob & Lever 16 | Cylinder Type | | |
| | Cylinder, Lever & LED 20 | Oval Cylinder - 32mm (H) x 18mm (W) Lockwood 570 Cylinders A | Non Compliant Lever/Knob Types | |
| | Cylinder, Fixed Lever & LED 21 | Guarded Oval Cylinder - 32mm (H) x 18mm (W) Lockwood 570 Cylinders B | 101 104 106 | |
| | Lever & LED 22 | No Cylinder Function - Selector S* | 123 178 97 | |
| | Cylinder & LED 23 | No Cylinder Function - Synergy N | 20 | |
| | Plate Function - Handed | <i>*Only applies to 13, 14, 16 and 39 functions</i> | Handed Levers | |
| | Cylinder & Fixed Lever 08 | | 41 122 153 | |
| | Fixed Lever Only 09 | | 98A | |
| | Disabled Turnknob & Lever 39 | | Angled Levers | |
| | | | P1 P1* ¹ 75* ² | |
| | | | Pull Handles | |
| | | | | <i>Handles are brass unless indicated otherwise</i> |
| | | | | ¹ = Stainless Steel |
| | | | | ² = Aluminium |
| | | | | ** Lever 65 and 85 not available in PS or PB |
| | | | | Handing |
| | | | | Left Handed L |
| | | | | Right Handed R |

Detention Series Square Plate Furniture



A heavy duty plate designed for use in hospitals and detention facilities. Styled for institutional use, this plate has six fixing points to ensure that it is well secured to the door. Plates are designed to be free of ligature points.

Application

Designed for use with Lockwood Selector 3770 and Synergy 3570 Series Mortice Locks as well as Lockwood 3579 Secure Area Rated Locks.

Features and Specifications

- Anti-ligature - Knob 21 & 22
- Covers fixing holes from existing Artefact 200 Series Furniture
- Detention furniture turns feature a clutching mechanism that allows the cylinder to retract the bolt even if the turnknob is held from the inside

Product Details

| | |
|------------------------|--|
| Dimensions | 162mm x 180mm x 2mm: base plate 161mm x 75mm x 3mm: bevelled top plate |
| Door Thickness* | 35mm minimum, 45mm maximum |
| Finishes | Satin Stainless Steel (SS) |
| Fixing | Six fixing points 220D series plates have concealed fixings 221D series plates have visible fixings |
| Handing | All plates are handed except 220D07, 220D24 and 220D31, which are non-handed when ordered without engraving. |
| Materials | Stainless steel |

*Note: A minimum door thickness of 50mm is required to fit flush pulls back to back.

Standards and Compliance



Fire Rated
Lockwood Detention Series Plate furniture have been successfully tested up to 2 hours with a fire rated Lockwood mortice lock on fire door assemblies (depending on type of doorset) in accordance with Australian Standard AS1905.1:2005, Fire Resistant Doorsets.

S3

High security for maximum protection (AS4145.2:1993).

D3

High durability for maximum frequency usage.



Anti-Corrosion

Detention Series Square Plate Lever/Knobs and Functions

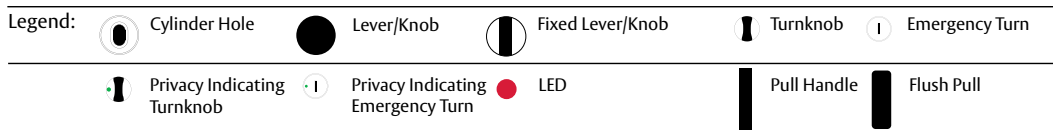
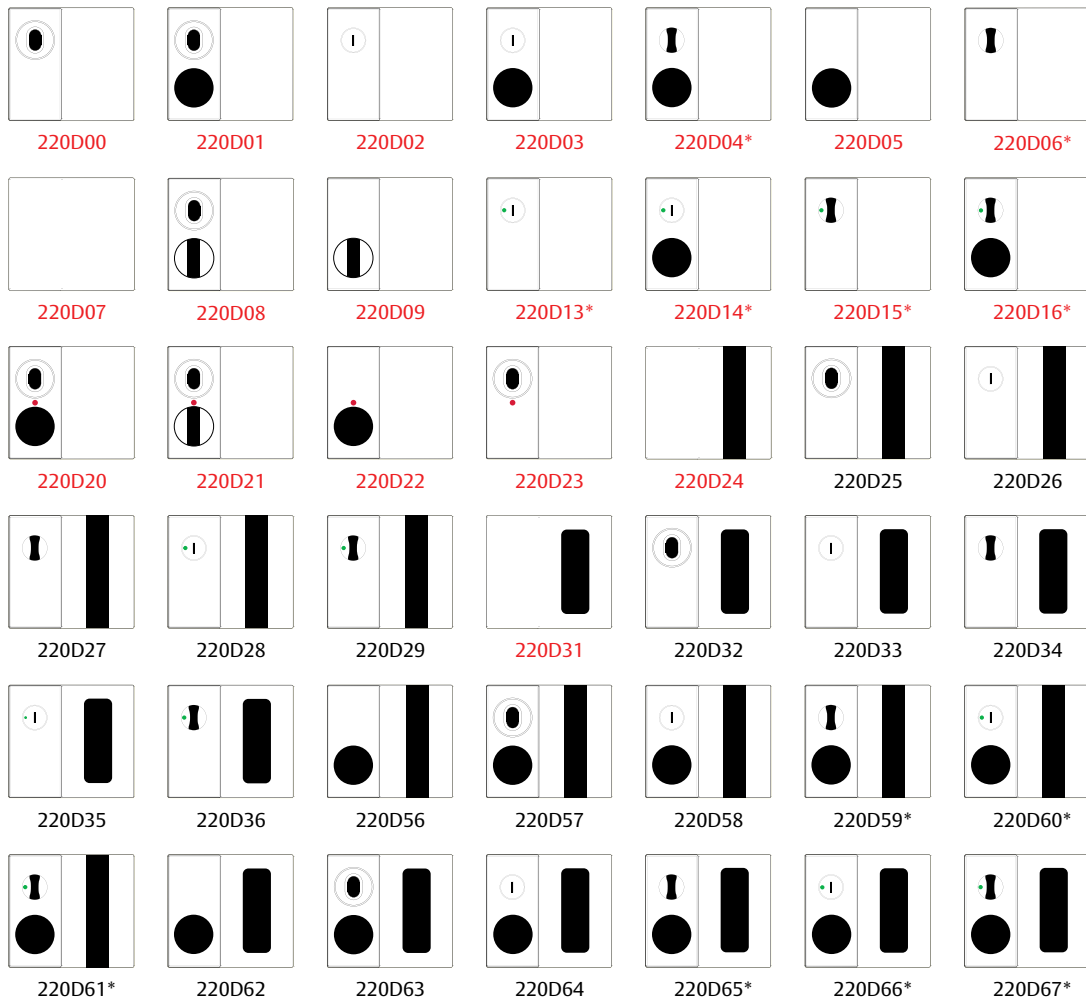

Cylinder guards must be ordered separately. Only the plate functions shown above in red are available with engraving.

* Refer to ordering procedure for part number when ordering with 3770 Series

Lever and Knob Selection

Standard Knob 21

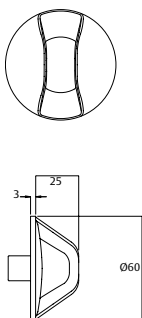

Webbed Knob 22

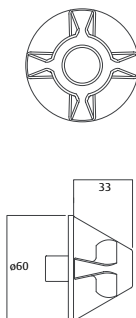

Lever 23

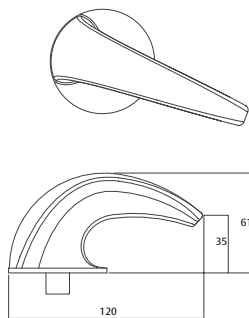

Detention Series Rectangular Plate Furniture



This smaller plate range has been designed for use in detention facilities such as hospitals where domestic aesthetics are preferred over institutional type styling. Plates are designed to be free of ligature points.

Application

Designed for use with Lockwood Selector 3770 and Synergy 3570 Series Mortice Locks as well as Lockwood 3579 Secure Area Rated Locks.

Features and Specifications

- Anti-ligature - Knob 21 & 22
- Covers fixing holes from existing 212 Series Artefact Plates
- Detention furniture turns feature a clutching mechanism that allows the cylinder to retract the bolt even if the turnknob is held from the inside

Product Details

| | |
|-----------------------|--|
| Dimensions | 162mm x 76mm x 2mm: base plate 161mm x 75mm x 3mm: bevelled top plate |
| Door Thickness | 35mm minimum, 45mm maximum |
| Finishes | Satin Stainless Steel (SS) |
| Fixing | Four fixing points 222D series plates have concealed fixings 223D series plates have visible fixings |
| Handing | Only plates with 23 Lever and / or turnknobs are handed |
| Materials | Stainless steel |

Standards and Compliance



Fire Rated
Lockwood Detention Series Plate furniture have been successfully tested up to 2 hours with a fire rated Lockwood mortice lock on fire door assemblies (depending on type of doorset) in accordance with Australian Standard AS1905.1:2005, Fire Resistant Doorsets.

S3

High security for maximum protection (AS4145.2:1993).

D3

High durability for maximum frequency usage.



Anti-Corrosion

Detention Series Rectangular Plate Lever/Knobs & Functions

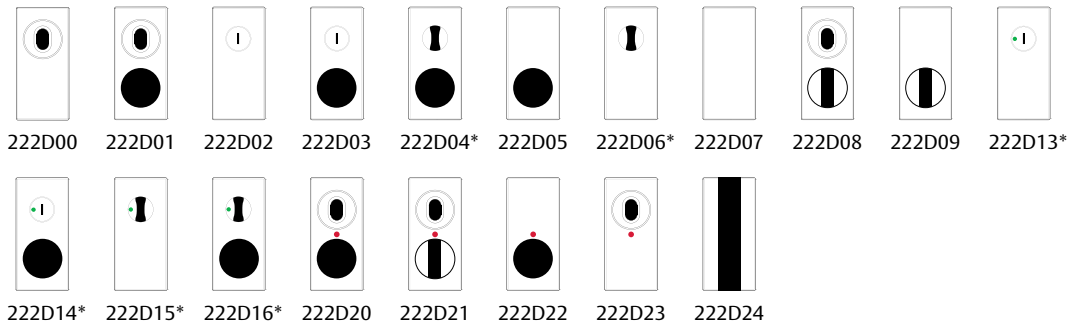

| | | | | | | | | | |
|--|-----------------------------|--|-----------------------------------|--|------------------|--|-------------|--|----------------|
| | Cylinder Hole | | Lever/Knob | | Fixed Lever/Knob | | Turnknob | | Emergency Turn |
| | Privacy Indicating Turnknob | | Privacy Indicating Emergency Turn | | LED | | Pull Handle | | |

* Refer to ordering procedure for part number when ordering with 3770 Series

Lever and Knob Selection

Standard Knob 21

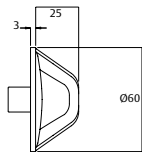
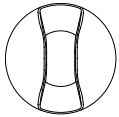

Webbed Knob 22

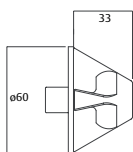

Lever 23

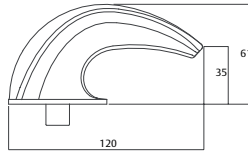
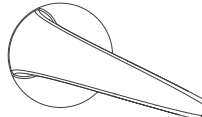

Detention Series – Knobs and Levers

Standard Knob 21

Simple yet functional, this knob has soft edges to minimise impact injuries and anti-ligature features that make it suitable for use in detention facilities.

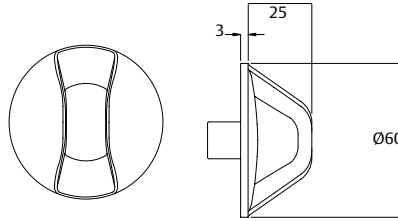

Webbed Knob 22

The webbed knob combines pleasing aesthetics, comfortable grip and anti-ligature features to provide a solution for any environment.

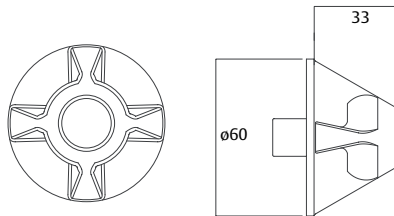

Lever 23

Ergonomically designed to maximise grip, the detention lever is suitable for use in hospitals and minimum security applications. It caters especially for the elderly or people with arthritic conditions.

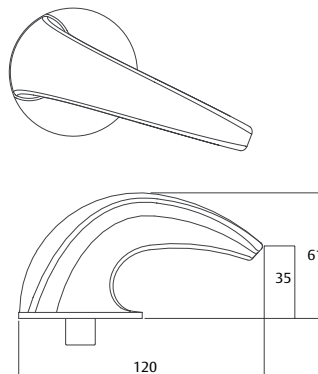

Detention Series – Turns

Emergency Turn

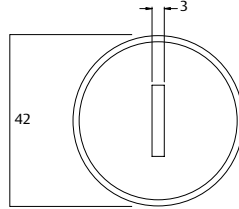

Turnknob

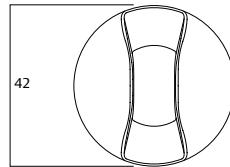

Privacy Indicating
Emergency Turn

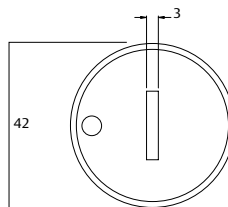

Privacy Indicating Turnknob

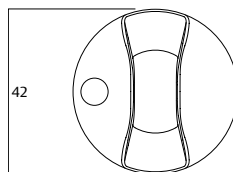

Detention Series – Pulls

Flush Pull

The detention flush pull has been designed to maximise grip and eliminate the possibility of hiding objects in the cavity.

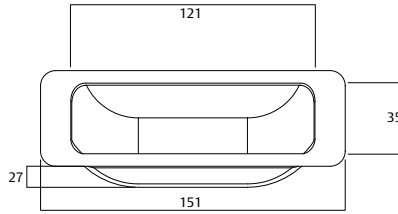

Standard Pull

The detention pull allows for a firm grip and can be used to open heavy doors. Also designed to be free of hanging points.

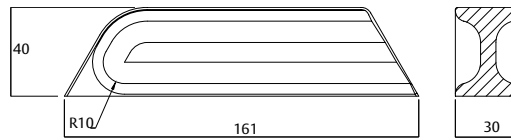

Detention Series – Accessories

Cylinder Guards

| Part Number | Door Thickness Suitability |
|-------------|----------------------------|
|-------------|----------------------------|

| | |
|-------------|--------------------|
| 220D00/40SS | Suit doors 35-40mm |
|-------------|--------------------|

| | |
|-------------|--------------------|
| 220D00/45SS | Suit doors 40-45mm |
|-------------|--------------------|

| | |
|-------------|--------------------|
| 220D00/50SS | Suit doors 45-50mm |
|-------------|--------------------|

| | |
|-------------|--------------------|
| 220D00/55SS | Suit doors 50-55mm |
|-------------|--------------------|

| | |
|-------------|--------------------|
| 220D00/60SS | Suit doors 55-60mm |
|-------------|--------------------|



Cylinder guards must be fitted with any cylinder plate function. Guards are available to suit different door thicknesses.

Fixing Screws

| Part Number | Description | Door Thickness Suitability |
|-------------|-------------|----------------------------|
|-------------|-------------|----------------------------|

| | | |
|-----------|-------------------------|-----------|
| 220D11/45 | Torx Anti-tamper Screws | 35 - 45mm |
|-----------|-------------------------|-----------|

| | | |
|-----------|-------------------------|-----------|
| 220D11/55 | Torx Anti-tamper Screws | 45 - 55mm |
|-----------|-------------------------|-----------|

| | | |
|-----------|-------------------------|-----------|
| 220D11/65 | Torx Anti-tamper Screws | 55 - 65mm |
|-----------|-------------------------|-----------|

| | | |
|-----------|-----------------|-----------|
| 220D12/45 | Standard Screws | 35 - 45mm |
|-----------|-----------------|-----------|

| | | |
|-----------|-----------------|-----------|
| 220D12/55 | Standard Screws | 45 - 55mm |
|-----------|-----------------|-----------|

| | | |
|-----------|-----------------|-----------|
| 220D12/65 | Standard Screws | 55 - 65mm |
|-----------|-----------------|-----------|

| | | |
|-----------|------------------|-----------|
| 220D13/50 | Snake-eye Screws | 35 - 50mm |
|-----------|------------------|-----------|

Torx anti-tamper, snake-eye and standard screws are available in accessory packs to suit different door thicknesses. Only standard screws to suit doors 35mm – 45mm thick are supplied with furniture. Other variations need to be ordered separately using part numbers specified.

All accessory packs contain six screws for the six mounting points per plate.

Screws are a M4 threaded screw with micro-encapsulation to provide resistance against coming loose. Screws are supplied with concealed fix furniture. For screws longer than 65mm, order SP0655MBK (75mm screws).

Detention Series Square Plate Furniture Ordering Procedure

When ordering 04, 06, 13, 14, 15, 16, 59, 60, 61, 65, 66 or 67 functions with 3770 series, refer to "Cylinder Type" specification for difference in part numbers.

Sample part number 220D01NA/21LSS is made up of several sections. Choose your product by selecting an option from each section.

| | | | | | | |
|--------------|-----------------|--------------------------|----------------------|--------------------|----------------|---------------|
| Plate | Function | Engraving Options | Cylinder Type | Lever/ Knob | Handing | Finish |
| 220 | D | N | A | 21 | L | SS |

Plate

| | |
|--------------------------------|-----|
| Concealed Fix 162mm x 180mm | 220 |
| Visible Fix 162mm x 180mm | 221 |

Function

| | |
|------------------|----|
| Plain Plate | 07 |
| Pull Handle Only | 24 |
| Flush Pull Only | 31 |

Function - Handed

| | |
|--|----|
| Cylinder Only | 00 |
| Cylinder and Lever/Knob | 01 |
| Emergency Turn Only | 02 |
| Emergency Turn and Lever | 03 |
| Turnknob and Lever/Knob | 04 |
| Lever/Knob Only | 05 |
| Turnknob Only | 06 |
| Cylinder and Fixed Lever/Knob | 08 |
| Fixed Lever/Knob Only | 09 |
| Privacy Indicating Emergency Turn Only | 13 |
| Privacy Indicating Emergency Turn and Lever/Knob | 14 |
| Privacy Indicating Turnknob Only | 15 |
| Privacy Indicating Turnknob and Lever/Knob | 16 |
| Cylinder, Lever/Knob and LED | 20 |
| Cylinder, Fixed Lever/Knob and LED | 21 |
| Lever/Knob and LED | 22 |
| Cylinder and LED | 23 |
| Pull Handle and Cylinder | 25 |
| Pull Handle and Emergency Turn | 26 |

Function - Handed cont.

| | |
|---|----|
| Pull Handle and Turnknob | 27 |
| Pull Handle and Privacy Indicating Emergency Turn | 28 |
| Pull Handle and Privacy Indicating Turnknob | 29 |
| Flush Pull and Cylinder | 32 |
| Flush Pull and Emergency Turn | 33 |
| Flush Pull and Turnknob | 34 |
| Flush Pull and Privacy Indicating Emergency Turn | 35 |
| Flush Pull and Privacy Indicating Turnknob | 36 |
| Pull Handle and Knob | 56 |
| Pull Handle, Cylinder and Knob | 57 |
| Pull Handle, Emergency Turn and Knob | 58 |
| Pull Handle, Turnknob and Knob | 59 |
| Pull Handle, Privacy Indicating Emergency Turn and Knob | 60 |
| Pull Handle, Privacy Indicating Turnknob and Knob | 61 |
| Flush Pull and Lever/Knob | 62 |
| Flush Pull and Cylinder and Lever/Knob | 63 |
| Flush Pull and Emergency Turn and Lever/Knob | 64 |
| Flush Pull and Turnknob and Lever/Knob | 65 |
| Flush Pull and Privacy Indicating Emergency Turn and Lever/Knob | 66 |
| Flush Pull and Privacy Indicating Turnknob and Lever/Knob | 67 |

Engraving Options

| | | |
|-----------------|---|---|
| Male Symbol | A | R |
| Male Text | B | S |
| Female Symbol | C | T |
| Female Text | D | U |
| Disabled Symbol | E | V |
| Push Text | F | W |
| Pull Text | G | X |
| Unisex Symbol | H | Y |
| No Option | | N |

For all in-filled engraving, black gloss is the standard.
A-G Outlined Infill
R-X Full Infill

Cylinder Type

| | |
|-------------------------------------|-----------------|
| Australian Oval | A |
| No Cylinder - Selector | S ¹ |
| No Cylinder - Synergy | N |
| No Cylinder / No Tailbar - Selector | SN ² |
| No Cylinder / No Tailbar - Synergy | NN |

¹Only applies to 04, 06, 13, 14, 15, 16, 59, 60, 61, 65, 66 and 67 functions.

²Only applies to 15, 16, 61 and 67 functions.

Knob

| | |
|---------------|----|
| Standard Knob | 21 |
| Webbed Knob | 22 |

Lever - Handed

| | |
|-------|-----|
| Lever | 23* |
|-------|-----|

Handing

| | |
|--------------|---|
| Left Handed | L |
| Right Handed | R |

*Lever cannot be used in combination with pull handle

Finish

| | |
|-----------------------|----|
| Satin Stainless Steel | SS |
|-----------------------|----|

Note: Cylinder guards must be ordered with all cylinder function plates. All turnknob functions are supplied with tailbars and clutching mechanisms as standard.

Detention Series Square Plate Furniture Ordering Procedure

When ordering 04, 06, 13, 14, 15 or 16 functions with 3770 series, refer to “Cylinder Type” specification for difference in part numbers.

Sample part number 222D04NS/21LSS is made up of several sections. Choose your product by selecting an option from each section.

| Plate | Function | Engraving Options | Cylinder Type | Lever/ Knob | Handing | Finish | |
|-------|----------|-------------------|---------------|-------------|---------|--------|----|
| 222 | D | 04 | N | S | 21 | L | SS |

| Plate | Engraving Options | Knob | Finish |
|---|---|---|---|
| Concealed Fix 162mm x 76mm 222 | Male Symbol A R Male Text B S Female Symbol C T Female Text D U Disabled Symbol E V Push Text F W Pull Text G X Unisex Symbol H Y No Option N | Standard Knob 21 Webbed Knob 22 | Satin Stainless Steel SS |
| Visible Fix 162mm x 76mm 223 | For all in-filled engraving, black gloss is the standard. A-G Outlined Infill R-X Full Infill | Lever - Handed Lever 23 | Note: Cylinder guards must be ordered with all cylinder function plates. All turnknob functions are supplied with tailbars and clutching mechanisms as standard. |
| Function | Cylinder Type Australian Oval A No Cylinder - Selector S*1 No Cylinder - Synergy N No Cylinder / No Tailbar - Selector SN*2 No Cylinder / No Tailbar - Synergy NN | Handing Left Handed L Right Handed R | |
| Cylinder Only 00 Cylinder and Lever/Knob 01 Emergency Turn Only 02 Emergency Turn and Lever 03 Lever/Knob Only 05 Plain Plate 07 Cylinder and Fixed Lever/Knob 08 Fixed Lever/Knob Only 09 Privacy Indicating Emergency Turn Only 13 Privacy Indicating Emergency Turn and Lever/Knob 14 Cylinder, Lever/Knob and LED 20 Cylinder, Fixed Lever/Knob and LED 21 Lever/Knob and LED 22 Cylinder and LED 23 | *1 Only applies to 04, 06, 13, 14, 15 and 16 functions. *2 Only applies to 15 and 16 functions. | | |
| Function - Handed | | | |
| Turnknob and Lever/Knob 04 Turnknob only 06 Privacy Indicating Turnknob Only 15 Privacy Indicating Turnknob and Lever/Knob 16 | | | |

Palladium® Series Door Furniture



The Palladium Series represents the highest standard in residential and semi-commercial door hardware and is brought to you through modern innovative designs, combined with quality manufacturing. A range of lever options is available to enable a common style throughout the home.

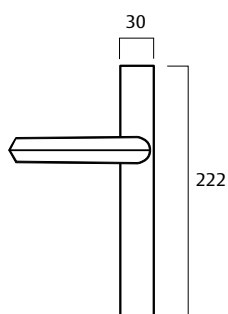

Product Details

| | |
|-----------------------|---|
| Dimensions | 222 x 30 x 9mm |
| Door Thickness | Minimum 32mm - maximum 45mm door thickness. |
| Finishes | Black (BLK) Polyester Powdercoat (PPC) Satin Chrome Pearl (SP) Satin Chrome Pearl New Zealand (SPNZ) |
| Fixing | Hole centres at 181mm |
| Handing | Easy, field selectable handing. |
| Materials | All plates and levers in the Palladium Series are constructed from solid zinc die-cast. |
| Screws | M4 Trilobial thread cutting screws Non-threaded screw posts |
| Keying | Use with Euro profile cylinder |
| Application | Used with Optimum and Union mortice locks, see table on page 48. |

Standards and Compliance

| | |
|---|--|
| S3 | High security for maximum protection (AS4145.2:2008). |
| D8 | Tested to AS4145.2 2008 for Durability passing D8 - 500,000 cycles. |
|  | Tested to AS4145.2 2008 for Neutral Salt Spray passing C6 Normal Corrosion Resistance - 168 Hours. |

French Door - PLFD Versions

These are used on the fixed door of a set of double doors. The outside furniture has no visible screws, no cylinder hole and the handle is fixed. The inside furniture has visible screw fixings, is used to operate two way locking and has a cylinder hole. This works with the cylinder supplied with the two way lock.

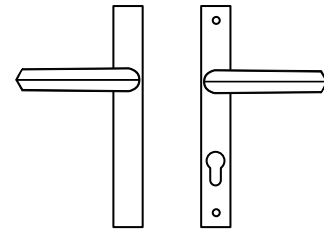

PLFD/85/##

Passage - PL1 Versions

These are used on the active door of either single or double doors. The outside furniture has no visible screws, no cylinder and the handle operates the latch on the lock. The inside furniture has visible screw fixings, no cylinder hole and the handle operates the latch on the lock.

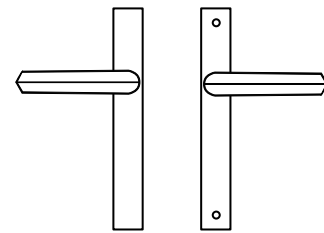

PL1/00/##

Double Cylinder - PL4 Versions

These are used on the active door of either single or double doors. The outside furniture has no visible screws, a cylinder hole and the handle operates the latch on the lock. The inside furniture has visible screw fixings, a cylinder hole and the handle operates the latch on the lock. Handles operate bolts when used with a compatible multi point lock.

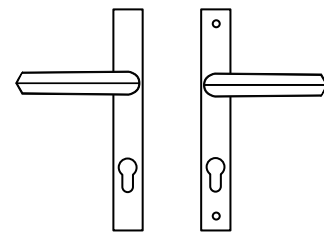

PL4/85/##

Dummy - PL5 Versions

These are used on the fixed door of a set of double doors. The outside furniture has no visible furniture screws, no cylinder hole and the handle is fixed. The inside furniture has visible screw fixings, no cylinder hole and the handle is fixed.

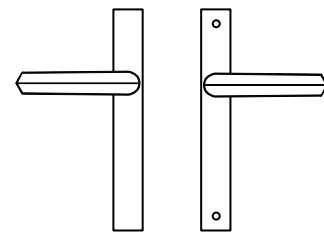

PL5/00/##

Indicating with Snib - PX4 Versions

These are used on the active door of either single or double doors. The outside furniture has no visible screws, a cylinder hole and the handle operates the latch on the lock. The inside furniture has visible screw fixings, a cylinder hole and the handle operates the latch on the lock. The snib on the inside locks and unlocks the handles and the indicator is red when the cylinder is locked.

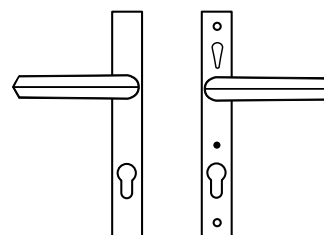

PX4/85/##

Palladium® Series Door Furniture

Summit® L1

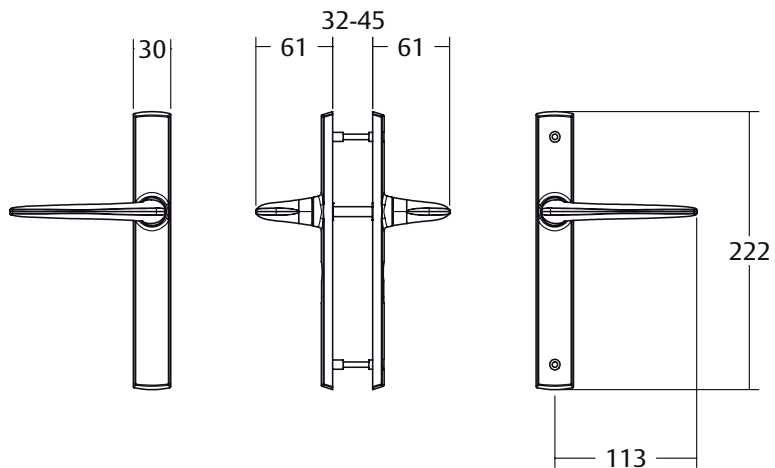

Aria® #27

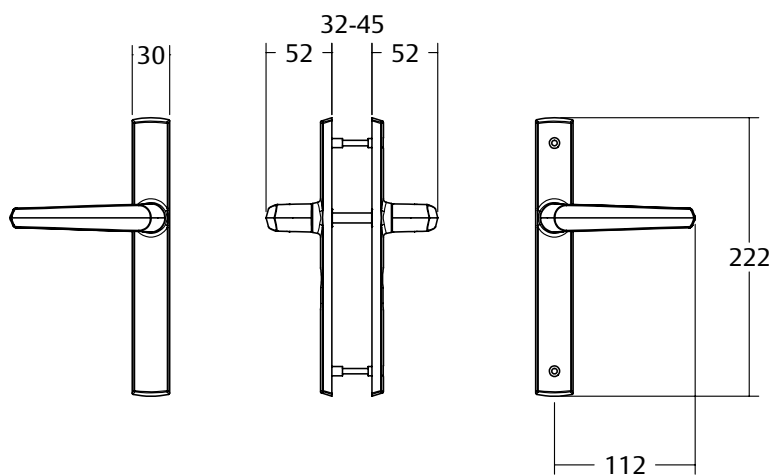

Acacia® #29

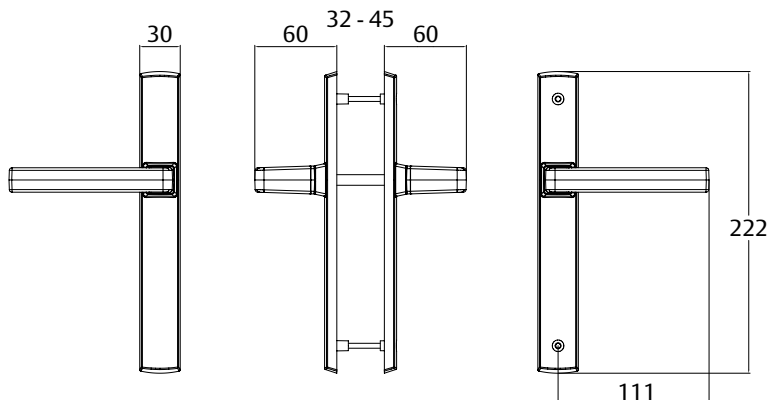

Palladium® Series Door Furniture

Acacia® #29A

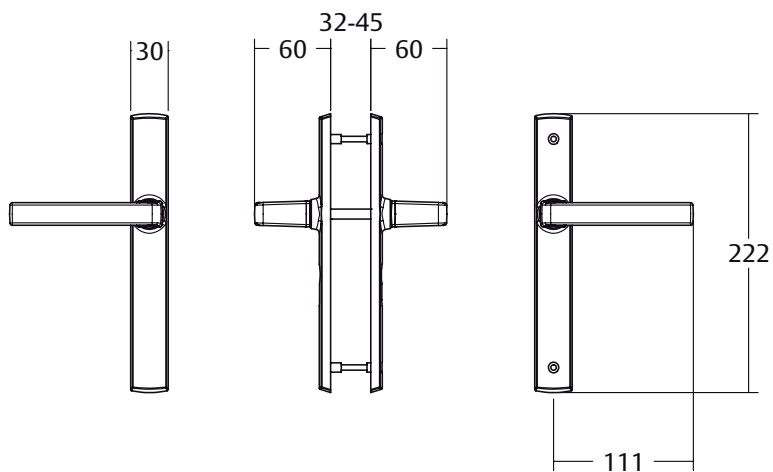

Gidgee® L37

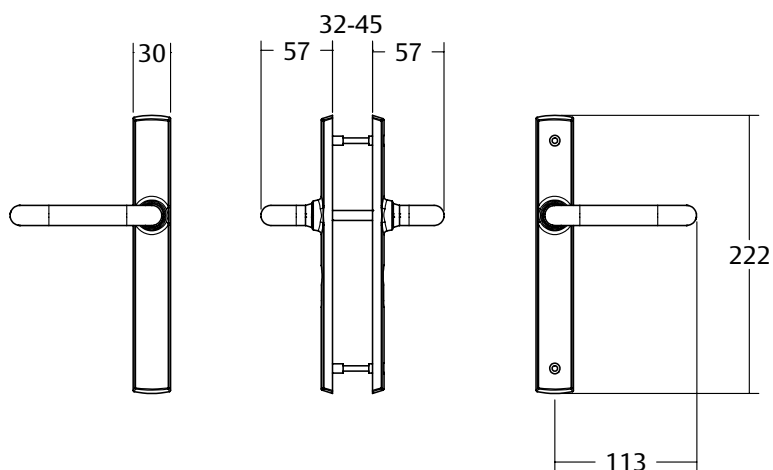

Diecast Levers

Acacia® #29

| | |
|-------------------------|-------|
| Part Number | #29 |
| Length | 122mm |
| Projection | 56mm |
| Finger clearance | 41mm |

*Design Registered Australia/New Zealand.

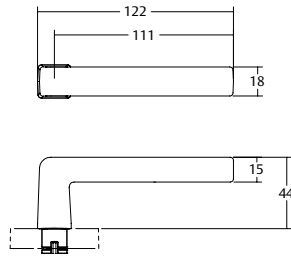

Acacia® #29A

| | |
|-------------------------|-------|
| Part Number | #29 |
| Length | 122mm |
| Projection | 56mm |
| Finger clearance | 41mm |

*Design Registered Australia/New Zealand.

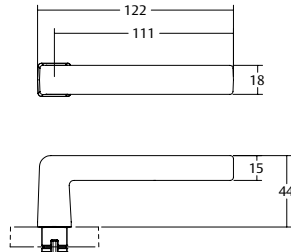

Aria® S27

| | |
|-------------------------|-------|
| Part Number | #27 |
| Length | 123mm |
| Projection | 48mm |
| Finger clearance | 36mm |

*Design Registered Australia/New Zealand.

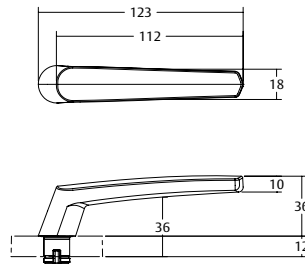

Gidgee® #37

| | |
|-------------------------|-------|
| Part Number | #37 |
| Length | 122mm |
| Projection | 53mm |
| Finger clearance | 37mm |

*Design Registered Australia/New Zealand.

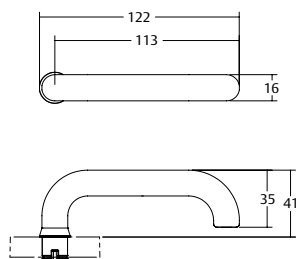

Diecast Levers

Summit® #L1

| | |
|-------------------------|-------|
| Part Number | #L1 |
| Length | 124mm |
| Projection | 57mm |
| Finger clearance | 37mm |

*Design Registered Australia/New Zealand.

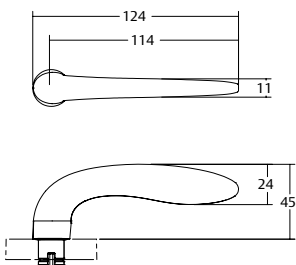

Palladium® Series Part Numbers

Double Cylinder Locking Furniture

| Lever 1 | Part Number | Barcode |
|-------------------------|---------------|---------------|
| Satin Chrome Pearl | PL4/85/L1SP | 9311847793781 |
| Black | PL4/85/L1BLK | 9311847793811 |
| Satin Chrome Pearl (NZ) | PL4/85/L1SPNZ | 9340116012506 |
| Powdercoat | PL4/85/L1PPC | 9311847793842 |

| Lever 27 | Part Number | Barcode |
|-------------------------|---------------|---------------|
| Satin Chrome Pearl | PL4/85/27SP | 9311847798519 |
| Black | PL4/85/27BLK | 9311847798458 |
| Satin Chrome Pearl (NZ) | PL4/85/27SPNZ | 9311847147355 |
| Powdercoat | PL4/85/27PPC | 9311847798496 |

| Lever 29 / 29A | Part Number | Barcode |
|-------------------------|---------------|---------------|
| Satin Chrome Pearl | PL4/85/29ASP | 9340116022826 |
| Black | PL4/85/29ABLK | 9340116022833 |
| Satin Chrome Pearl (NZ) | PL4/85/29SPNZ | 9340116023403 |
| Powdercoat | PL4/85/29PPC | 9311847797307 |

| Lever 37 | Part Number | Barcode |
|-------------------------|---------------|---------------|
| Satin Chrome Pearl | PL4/85/37SP | 9311847798670 |
| Black | PL4/85/37BLK | 9311847798618 |
| Satin Chrome Pearl (NZ) | PL4/85/37SPNZ | 9340116028750 |
| Powdercoat | PL4/85/37PPC | 9311847798656 |

French Door Sets

| Lever 1 | Part Number | Barcode |
|--------------------|---------------|---------------|
| Satin Chrome Pearl | PLFD/85/L1SP | 9311847810839 |
| Black | PLFD/85/L1BLK | 9311847810808 |

| Lever 27 | Part Number | Barcode |
|--------------------|---------------|---------------|
| Satin Chrome Pearl | PLFD/85/27SP | 9311847810433 |
| Black | PLFD/85/27BLK | 9311847810402 |

Passage Sets

| Lever 27 | Part Number | Barcode |
|-------------------------|---------------|---------|
| Black | PL1/00/27BLK | |
| Satin Chrome Pearl (NZ) | PL1/00/27SPNZ | |
| Powdercoat | PL1/00/27PPC | |

Dummy Sets

| Lever 27 | Part Number | Barcode |
|-------------------------|---------------|---------|
| Black | PL5/00/27BLK | |
| Satin Chrome Pearl (NZ) | PL5/00/27SPNZ | |
| Powdercoat | PL5/00/27PPC | |

Palladium® Series Part Numbers

Indicating & Snib - Double Cylinder Locking Furniture

| Lever 1 | Part Number | Barcode |
|-------------------------|---------------|---------------|
| Satin Chrome Pearl | PX4/85/L1SP | 9311847105522 |
| Black | PX4/85/L1BLK | 9311847105492 |
| Satin Chrome Pearl (NZ) | PX4/85/L1SPNZ | 9340116027173 |
| Powdercoat | PX4/85/L1PPC | 9311847105515 |

| Lever 27 | Part Number | Barcode |
|-------------------------|---------------|---------------|
| Satin Chrome Pearl | PX4/85/27SP | 9311847989405 |
| Black | PX4/85/27BLK | 9311847989412 |
| Satin Chrome Pearl (NZ) | PX4/85/27SPNZ | 9311847119260 |
| Powdercoat | PX4/85/27PPC | 9311847105225 |

| Lever 29 / 29A | Part Number | Barcode |
|-------------------------|---------------|---------------|
| Satin Chrome Pearl | PX4/85/29ASP | 9340116022802 |
| Black | PX4/85/29ABLK | 9340116022819 |
| Satin Chrome Pearl (NZ) | PX4/85/29SPNZ | 9340116027180 |
| Powdercoat | PX4/85/29PPC | 9311847105355 |

| Lever 37 | Part Number | Barcode |
|-------------------------|---------------|---------------|
| Satin Chrome Pearl | PX4/85/37SP | 9311847105485 |
| Black | PX4/85/37BLK | 9311847105454 |
| Satin Chrome Pearl (NZ) | PX4/85/37SPNZ | 9340116028767 |
| Powdercoat | PX4/85/37PPC | 9311847105478 |

Palladium® Series Part Numbers

| Application | | | | | |
|----------------|--|----|----|------|--|
| Item Number | Product Name | PL | PX | PLFD | |
| OP30/1LAN/SS | OPTIMUM 1PT HINGED 30MM BACKSET TP | ✓ | ✗ | ✗ | |
| OP30/2PTL/SS | OPTIMUM 2PT HINGED 24MM BOLT 30MM BACKSET TP | ✓ | ✓ | ✗ | |
| OP30/2PTL/SSBL | OPTIMUM 2PT HINGED BEVEL BOLT 24MM BOLT 30MM BACKSET PK=25 | ✓ | ✓ | ✗ | |
| OP30/2PTS/SS | OPTIMUM 2PT HINGED 13MM BOLT 30MM BACKSET TP | ✓ | ✓ | ✗ | |
| OP30/2PTS/SSBL | OPTIMUM 2PT HINGED BEVEL BOLT 30MM BACKSET PK=25 TP | ✓ | ✓ | ✗ | |
| OP30/4PTS/SSBL | OPTIMUM 4PT HINGED SHOOT BEVEL BOLT 30MM BACKSET PK=25 TP | ✓ | ✓ | ✗ | |
| OP30/4RML/SS | OPTIMUM 4PT HINGED REMOTES 24MM BOLT 30MM BACKSET | ✓ | ✓ | ✗ | |
| OP30/4RML/SSBL | OPTIMUM 4PT HINGED REMOTES 24MM BOLT 30MM B/SET BEVEL BOLT & 2 PACKERS | ✓ | ✓ | ✗ | |
| OP30/4RMS/SS | OPTIMUM 4PT HINGED REMOTES 13MM BOLT 30MM BACKSET | ✓ | ✓ | ✗ | |
| OP30/4SBL/SS | OPTIMUM 4PT HINGED SHOOT BOLT 24MM BOLT 30MM BACKSET TP | ✓ | ✓ | ✗ | |
| OP30/4SBS/SS | OPTIMUM 4PT HINGED SHOOT BOLT 13MM BOLT 30MM BACKSET TP | ✓ | ✓ | ✗ | |
| OP40/2PTL/SS | OPTIMUM 2PT HINGED 24MM BOLT 40MM BACKSET TP | ✓ | ✓ | ✗ | |
| OP40/4SBS/SS | OPTIMUM 4PT HINGED SHOOT BOLT 13MM BOLT 40MM BACKSET TP | ✓ | ✓ | ✗ | |
| OP50/2PTL/SS | OPTIMUM 2PT HINGED 24MM BOLT 50MM BACKSET | ✓ | ✓ | ✗ | |
| U-X925-SS-M5 | UNION 85MM PITCH EURO MORTICE LOCK 25MM BACKSET TP | ✓ | ✗ | ✗ | |
| U-X930-SS-M5 | UNION 85MM PITCH EURO MORTICE LOCK 30MM BACKSET | ✓ | ✗ | ✗ | |
| U-X935-SS-M5 | UNION 85MM PITCH EURO MORTICE LOCK 35MM BACKSET | ✓ | ✗ | ✗ | |
| P84318NRA | TBL FR DR NO FURN/CYL *NO RODS | ✗ | ✗ | ✓ | |

Note: For further information, please refer to the Euro Profile Mortice Locks catalogue.

Brass Furniture Thicker Door Accessories

Lockwood Brass Door Furniture is suitable for use across a wide range of door thicknesses. In certain applications longer screws, spindles and turnknob tailbars may be required.

Screws

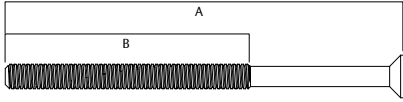

Screws

| Part Number | Pack Size | Length (A) | Threaded Length (B) | Door Thickness | |
|--------------|-----------|------------|---------------------|----------------|-------|
| | | | | Min | Max |
| SPA20-V3 NSS | 20 | 65mm | 40mm | 32mm | 50mm |
| SP0655MBK | 10 | 75mm | 40mm | 42mm | 60mm |
| SP1800-608ZP | 10 | 120mm | 75mm | 52mm | 105mm |
| SP1800-208SS | 10 | 215mm | 125mm | 97mm | 200mm |

Note: Item shown is red is the standard screw that is supplied with furniture. Consideration should be given to screw finish on furniture platforms featuring visible fixing.

Mortice Lock Spindles

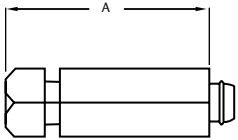

Mortice Lock Spindles

| Part Number | Pack Size | Length (A) | Door Thickness | |
|-------------|-----------|------------|----------------|-------|
| | | | Min | Max |
| SP3570-5018 | 10 | 33mm | 35mm | 50mm |
| SP3570-5228 | 10 | 45mm | 50mm | 75mm |
| SP3570-5238 | 1 | 58mm | 75mm | 100mm |

In thicker door scenarios when Lockwood Brass Door Furniture is used with Lockwood Selector or Synergy Series Mortice Locks, longer spindles may be required.

Turnknob Tailbars

The door thickness range for a turnknob tailbar will depend on whether the turn is in a cylinder and turn configuration or a privacy (turn and turn) configuration

Turnknob Tailbars

| Part Number | Pack Size | Length |
|-------------|-----------|--------|
| SP571-38ZP | 10 | 47mm |
| SP571-138ZP | 1 | 98mm |

Note: Item shown is red is the standard tailbar that is supplied with furniture.

Lockwood Door Furniture Handing Convention

Applicable for All Handed Furniture

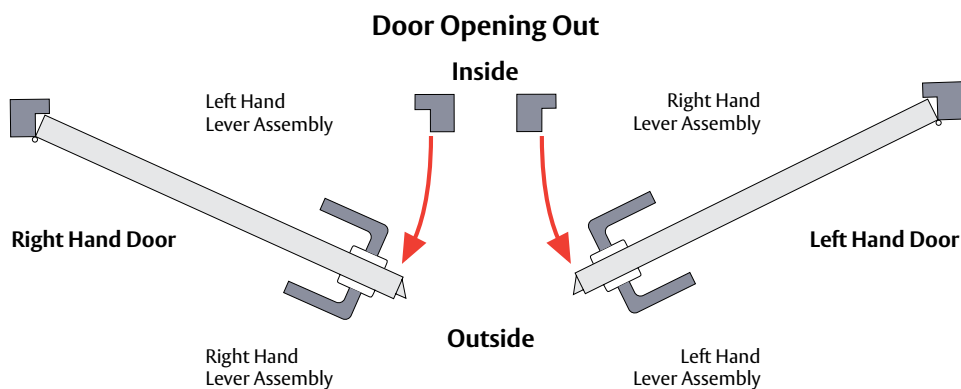
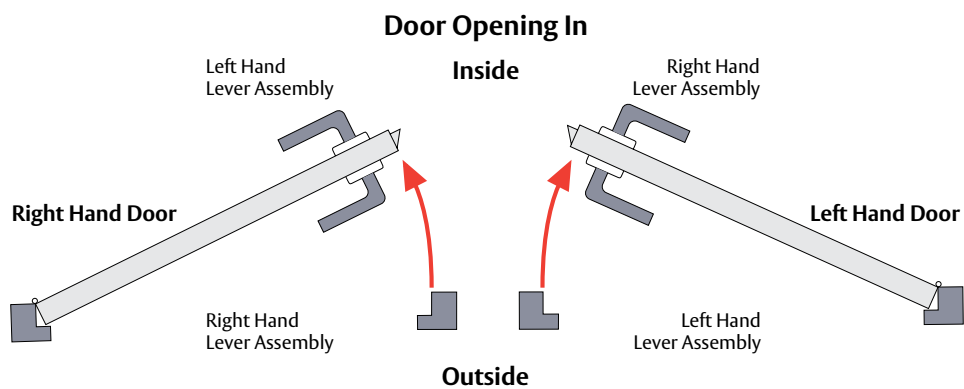

Metal Finishes

For Metal Finish sample refer to code under each image.



Antique Copper (AC)
Sample Code: FIN-SAMPLEAC*



Architectural Bronze Unlacquered (AU)
Sample Code: FIN-SAMPLEAU*



Oil Rubbed Bronze (ORB)
Sample Code: FIN-SAMPLEORB*

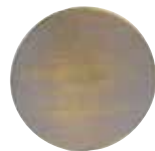

Aged Brass (AG)
Sample Code: FIN-SAMPLEAG*

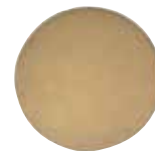

Architectural Bronze (AZ)
Sample Code: FIN-SAMPLEAZ**



Polished Brass (PB)
Sample Code: FIN-SAMPLEPB**



Satin Brass (SB)
Sample Code: FIN-SAMPLESB**



Polished Brass Unlacquered (BU)
Sample Code: FIN-SAMPLEBU*



Satin Brass Unlacquered (SBU)
Sample Code: FIN-SAMPLESBU*



Satin Chrome Plating (SC)
Sample Code: FIN-SAMPLESC



Chrome Plating (CP)
Sample Code: FIN-SAMPLECP



Stainless Steel (SS)
Sample Code: FIN-SAMPLESS



Polished Stainless Steel (PS)
Sample Code: FIN-SAMPLEPS



Natural Anodized Aluminium (NT)
Sample Code: FIN-SAMPLENT

NOTE: Not all decorative finishes apply to every Lockwood product. Refer to the table at the end of this document for specific decorative finishes applicable per series.

*Unlacquered Metal Finish. This finish will naturally age and its appearance will change over time according to the environment and use it is exposed to. For more information on the aging effect of a particular finish contact your ASSA ABLOY representative.

**Finish is protected by a top clear lacquer.

Disclaimer: Product Colours displayed in this catalogue have been matched to indoor viewing and colour appearance may vary according to light source and medium and as such should be used as indicative only. As actual colour on the end product may vary, always confirm your colour choice with production line prepared samples from your ASSA ABLOY representative for final colour approval. For warranty terms and conditions on Lockwood Products and its finishes, please visit www.lockweb.com.au or call 1300WARRANTY

Dulux Powdercoat Finishes

For Powdercoat Finish sample order code:

FIN-SAMPLEPC specify the desired color from the images below when placing order.

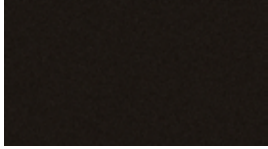

Dulux Duratec Eternity
Eternity Charcoal Pearl
Satin

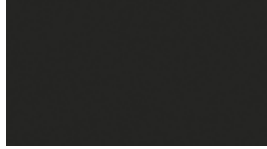

Dulux Electro
Black Ace
Flat

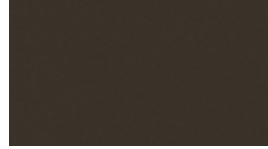

Dulux Electro
Dark Bronze
Flat

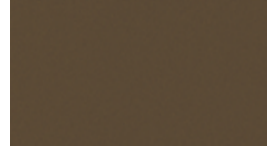

Dulux Electro
Medium Bronze
Flat

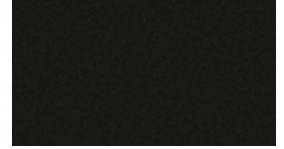

Dulux Precious
Charcoal Metallic Pearl
Gloss



Dulux Precious
Citi Pearl
Matt



Dulux Precious
Natural Pearl
Matt



Dulux Precious
Nickel Pearl
Matt



Dulux Precious
Sharp Silver Kinetic® Pearl
Satin



Dulux Precious
Silver Kinetic® Pearl
Satin

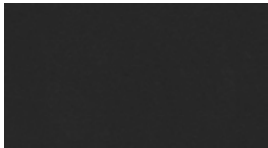

Dulux Surreal Effects Mannex
Mannex Black
Effect



Dulux Surreal Effects Scylla
Red Brown Scylla
Effect

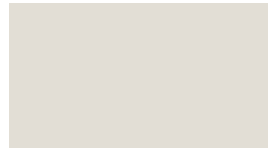

Dulux Duralloy
Shoji White
Satin

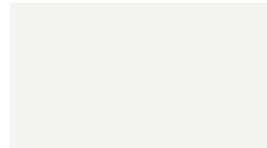

Dulux Alphatec
White
Matt

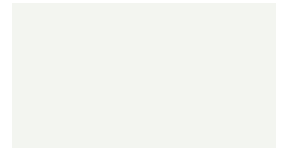

Dulux Duralloy
White
Satin



Dulux Duralloy
Black
Gloss



Dulux Duralloy
Monument®
Satin

CB



Dulux Duralloy
Black (C/B Night Sky®)
Satin

CB



Dulux Duralloy
Dune®
Satin

CB



Dulux Duralloy
Woodland Grey®
Satin

CB

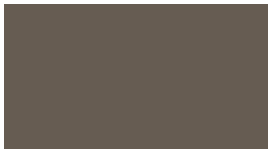

Dulux Duralloy
Jasper®
Satin

CB



Dulux Duralloy
Monument®
Matt

CB



Dulux Duralloy
Deep Ocean®
Satin

CB



Dulux Duralloy
Woodland Grey®
Matt

CB



Dulux Duralloy
APO Grey
Satin

NOTE: Not all Powdercoat Finishes apply to every Lockwood product. Refer to the notes at the end of this document for specific decorative finishes applicable per series.

CB Colorbond and the Colorbond colour names are registered trademarks of Bluescope Steel Limited



We recommend and use Dulux Powders

Disclaimer: Dulux, Duralloy, Anotec, Silver Kinetic, are registered trade marks of DuluxGroup (Australia) Pty Ltd. Monument, Night Sky, Dune, Woodland Grey, Jasper, Deep Ocean, Surfist, Pale Eucalypt, Paperbark, are registered trademarks of Bluescope Steel Limited. Product Colours displayed in this catalogue have been matched to indoor viewing and colour appearance may vary according to light source and medium and as such should be used as indicative only. As actual colour on the end product may vary, always confirm your colour choice with production line prepared samples from your ASSA ABLOY representative for final colour approval. For warranty terms and conditions on Lockwood Products and its finishes, please visit www.lockweb.com.au or call 1300WARRANTY

Dulux Powdercoat Finishes

For Powdercoat Finish sample order code:

FIN-SAMPLEPC specify the desired color from the images below when placing order.

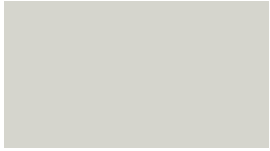

Dulux Duralloy
Surfmist®
Matt

CB

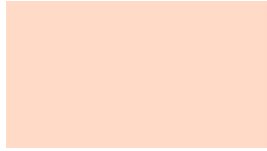

Dulux Duralloy
Anotec® Off White
Matt



Dulux Duralloy
Anotec® Mid Bronze
Matt



Dulux Duralloy
Dune®
Matt

CB



Dulux Duralloy
Anotec® Dark Grey
Matt

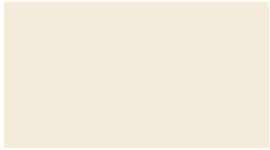

Dulux Duralloy
White Birch
Gloss



Dulux Duralloy
Stone Beige
Matt



Dulux Duralloy
Notre Dame
Gloss



Dulux Duralloy
Pale Eucalypt®
Satin

CB



Dulux Duralloy
Magnolia
Gloss



Dulux Duralloy
Doeskin
Satin



Dulux Duralloy
Paperbark®
Satin

CB



Dulux Duralloy
Classic Hawthorn Green
Gloss



Dulux Duralloy
Primrose
Gloss



Dulux Duralloy
Black (C/B Night Sky®)
Matt

CB

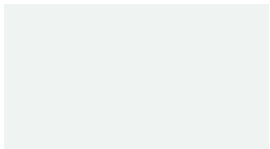

Dulux Duralloy
Pearl White
Gloss

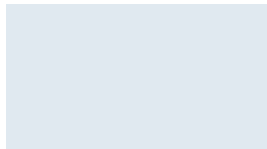

Dulux Duralloy
Bright White
Gloss

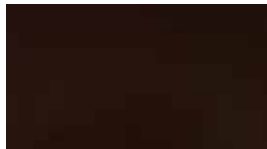

Dulux Precious
Mahogany Gloss Pearl



Dulux Surreal Effects
Black Gold
Gloss



Dulux Duralloy
Charcoal Lustre
Matt



Dulux Alphatec
Ranch Brown
Satin

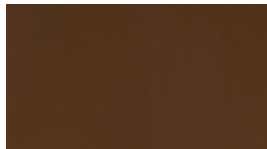

Dulux Duralloy
Coffee
Satin

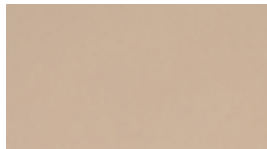

Dulux Duralloy
Pottery
Satin

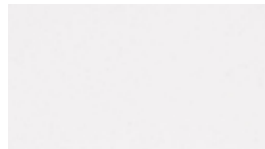

Dulux Duralloy
White Lustre
Matt

NOTE: Not all Powdercoat Finishes apply to every Lockwood product. Refer to the notes at the end of this document for specific decorative finishes applicable per series.

CB Colorbond and the Colorbond colour names are registered trademarks of Bluescope Steel Limited



We recommend and use Dulux Powders

Disclaimer: Dulux, Duralloy, Anotec, Silver Kinetic, are registered trade marks of DuluxGroup (Australia) Pty Ltd. Monument, Night Sky, Dune, Woodland Grey, Jasper, Deep Ocean, Surfist, Pale Eucalypt, Paperbark, are registered trademarks of Bluescope Steel Limited. Product Colours displayed in this catalogue have been matched to indoor viewing and colour appearance may vary according to light source and medium and as such should be used as indicative only. As actual colour on the end product may vary, always confirm your colour choice with production line prepared samples from your ASSA ABLOY representative for final colour approval. For warranty terms and conditions on Lockwood Products and its finishes, please visit www.lockweb.com.au or call 1300WARRANTY

Decorative Finishes Per Series

Powdercoat Finishes

Rose Door Handles: Robert Watson, 1220, 1420, 1360, 1370, 260, 260SQ

Plate Door Handles: 1800, 2800, 4800, 5800, 200, 202, 212, 224

Push/Pull Plates: 218/219, 206/207, 208/209, 214/215, 216/217, 184, 185

Metal Finishes

Use table below as a reference for the applicable finish to each Lockwood Series.

Refer to the series catalogue for specific detailed information.

| Reference Table | | | | | | | | | |
|---------------------------------------|--|---|--|--|---|--|------------------------------------|---|--|
| | Brass Series Rose Door Handles 1220, 1420, 1360, 1370 | Brass Series Plate Door Handles 1800, 2800, 4800, 5800 | Artefact Series Rose Door Handles 260 | Artefact Series Rose Door Handles 260SQ | Artefact Series Plate Door Handles 200, 202, | Artefact Series Plate Door Handles 212, 224 | Push/Pull Plate Series 184, 185 | Push/Pull Plate Series 214/215, 216/217, 218/219 | Push/Pull Plate Series 206/207, 208/209 |
| Antique Copper (AC) | ✓ | ✓ | ✓ | ✗ | ✓ | ✗ | ✓ | ✓ | ✗ |
| Architectural Bronze Unlacquered (AU) | ✓ | ✓ | ✓ | ✗ | ✓ | ✗ | ✓ | ✓ | ✗ |
| Oil Rubbed Bronze (ORB) | ✓ | ✓ | ✓ | ✗ | ✓ | ✗ | ✓ | ✓ | ✗ |
| Aged Brass (AG) | ✓ | ✓ | ✓ | ✗ | ✓ | ✗ | ✓ | ✓ | ✗ |
| Architectural Bronze (AZ) | ✓ | ✓ | ✓ | ✗ | ✓ | ✗ | ✓ | ✓ | ✗ |
| Polished Brass (PB) | ✓ | ✓ | ✓ | ✗ | ✓ | ✗ | ✓ | ✓ | ✗ |
| Satin Brass (SB) | ✓ | ✓ | ✓ | ✗ | ✓ | ✗ | ✓ | ✓ | ✗ |
| Polished Brass Unlacquered (BU) | ✓ | ✓ | ✓ | ✗ | ✓ | ✗ | ✓ | ✓ | ✗ |
| Satin Brass Unlacquered (SBU) | ✓ | ✓ | ✓ | ✗ | ✓ | ✗ | ✓ | ✓ | ✗ |
| Satin Chrome Plating (SC) | ✓ | ✓ | ✗ | ✗ | ✗ | ✗ | ✓ | ✗ | ✗ |
| Chrome Plating (CP) | ✓ | ✓ | ✗ | ✗ | ✗ | ✗ | ✓ | ✗ | ✗ |
| Stainless Steel (SS) | ✗ | ✗ | ✓ | ✓ | ✓ | ✓ | ✗ | ✓ | ✓ |
| Polished Stainless Steel (PS) | ✗ | ✗ | ✓ | ✗ | ✓ | ✓ | ✗ | ✓ | ✓ |
| Marine Grade Stainless Steel (MG) | ✗ | ✗ | ✓ | ✗ | ✓ | ✓ | ✗ | ✓ | ✓ |
| Natural Anodised Aluminium (NT) | ✗ | ✗ | ✓ | ✗ | ✓ | ✓ | ✗ | ✗ | ✗ |

Disclaimer: Product Colours displayed in this catalogue have been matched to indoor viewing and colour appearance may vary according to light source and medium and as such should be used as indicative only. As actual colour on the end product may vary, always confirm your colour choice with production line prepared samples from your ASSA ABLOY representative for final colour approval. For warranty terms and conditions on Lockwood Products and its finishes, please visit www.lockweb.com.au or call 1300WARRANTY



ASSA ABLOY

Lockwood is the leading brand in the Australian locking industry. With an established reputation for high quality products, this iconic brand provides a wide range of locking solutions to residential housing, commercial, semi-commercial, building and industrial application markets. Lockwood is supported by an extensive distribution and after-sales support network. Our customers include retailers, architects, trade and industrial personnel, locksmiths and security dealers.

ASSA ABLOY is the global leader in door opening solutions, dedicated to satisfying end-user needs for security, safety and convenience.

ASSA ABLOY is represented in all major regions, in both mature and emerging markets, with leading positions in Australia, Europe and North America.

**25YEAR
MECHANICAL
WARRANTY**

The Lockwood 25 Year Mechanical Warranty

Our belief that we manufacture the finest premium products available in today's market place is backed by the Lockwood 25 Year Mechanical Warranty, ensuring that Lockwood continues to keep Australians safe by delivering security and peace of mind.

For warranty terms and conditions, please visit www.lockweb.com.au or call **1300WARRANTY**

ASSA ABLOY Australia Pty Ltd
235 Huntingdale Road
Oakleigh, Victoria, 3166
Australia

1300 LOCK UP (1300 562 587)
lockweb.com.au

ASSA ABLOY New Zealand Ltd
6 Armstrong Road
Albany, Auckland, 0632
New Zealand

info.nz@assaabloy.com
Telephone +64 9415 7111
assaabloy.co.nz

Disclaimer

Whilst every effort has been made to ensure that the information (including product images and drawings) contained in this brochure is accurate at the time of publication, ASSA ABLOY Australia Pty Limited ("ASSA ABLOY") recommends that you consult ASSA ABLOY or its agents prior to placing an order to ascertain current information on specific products, as ASSA ABLOY reserves the right to make changes without notice. ASSA ABLOY will not be liable for any injury, loss or damage whatsoever, arising from any errors or omissions in the information contained in the brochure or arising from the use or application of the information contained herein. © 2018 copyright by ASSA ABLOY All rights reserved

